

# HISTORICAL COLLECTION

## WORLD WAR II

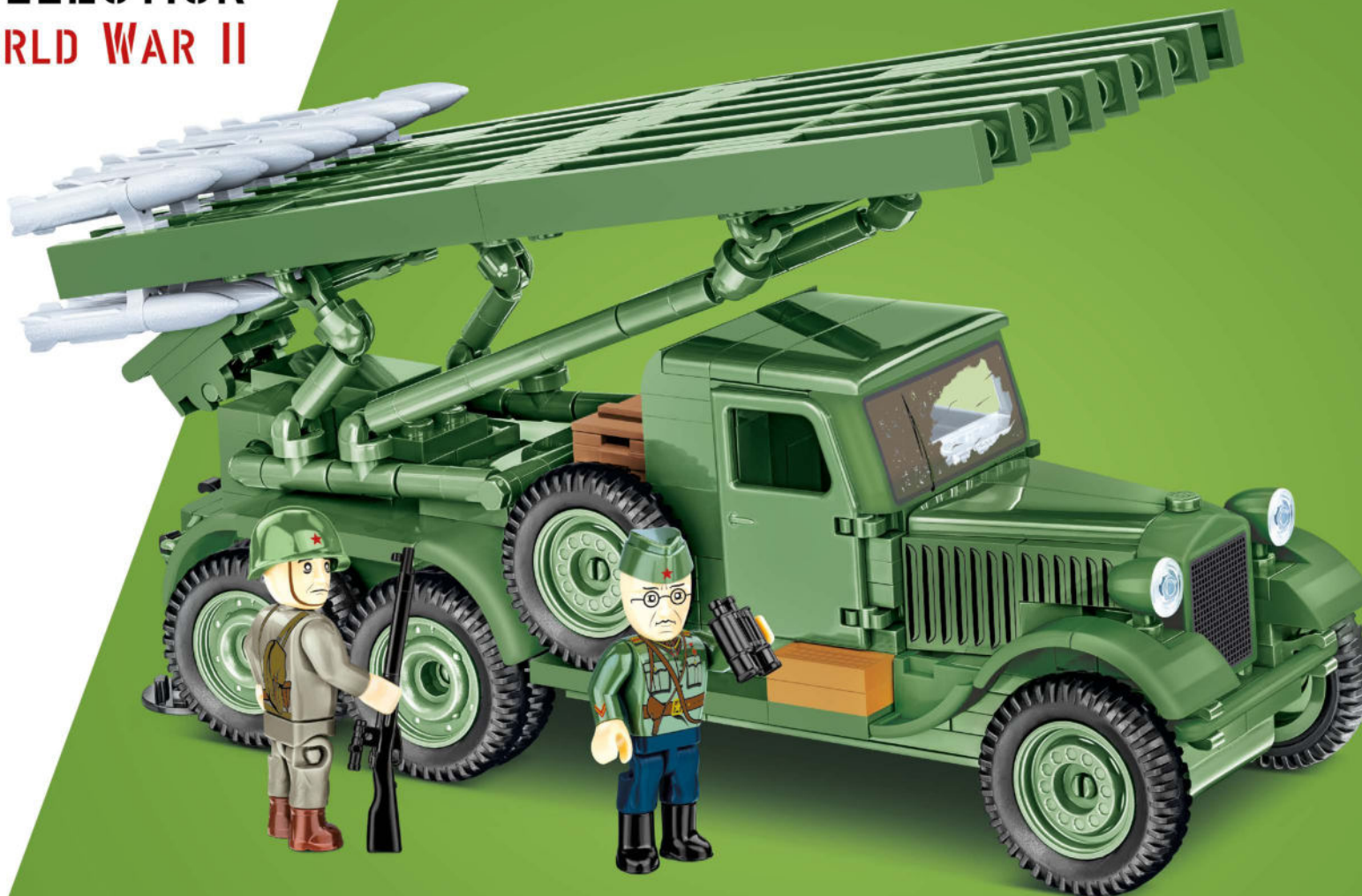

**BM-13 KATYUSHA**  
 IN SERVICE - 1941 - 1945  
 PLACE OF ORIGIN - SOVIET UNION  
 TYPE - MULTIPLE ROCKET LAUNCHER  
 AMMUNITION - 16x 132mm (5.2") M-13 ROCKET

**ZIS-6**  
 IN SERVICE - 1933 - 1940s  
 PLACE OF ORIGIN - SOVIET UNION  
 TYPE - TRUCK  
 LENGTH - 6,06m (19' 10")  
 WIDTH - 2,23m (7' 4")  
 WEIGHT - 4230kg (9325LB)  
 ENGINE - SIX-CYLINDER ZIS-5, 54kW (73HP)  
 MAXIMUM SPEED - 55KM/H (34MPH) ★

2280

**PAD PRINTED**  
**NO STICKERS**

**Printed in EU**



**WARNING: CHOKING HAZARD-**  
 Toy contains small parts.  
 Not for children under 3 years.

440 2

**BM-13 KATYUSHA (ZIS-6)**

**SCALE 1:35**

1

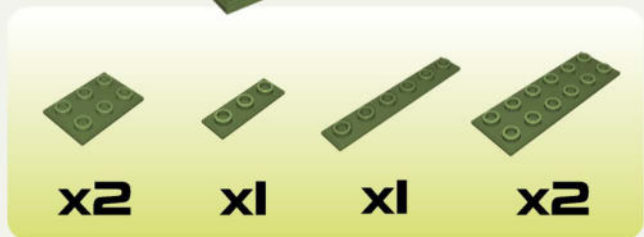
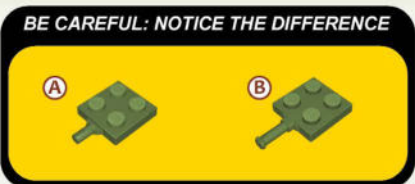
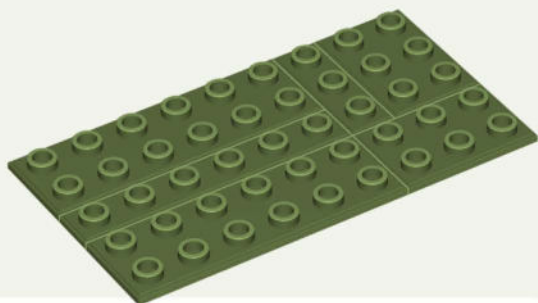

2

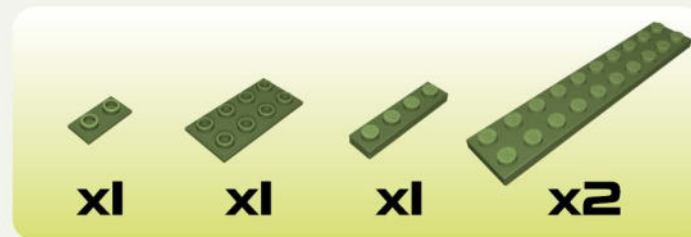
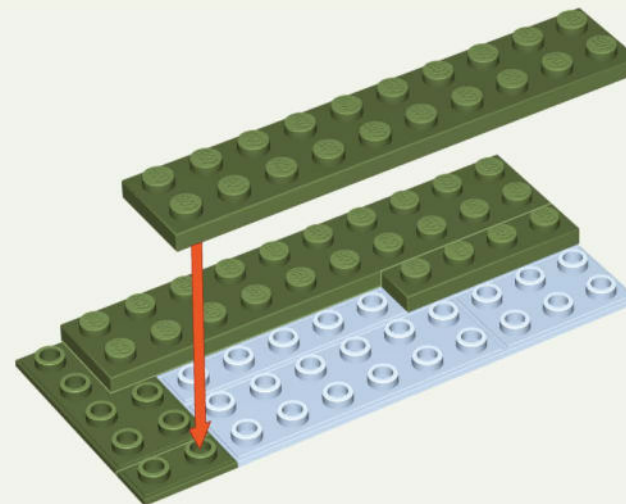

3

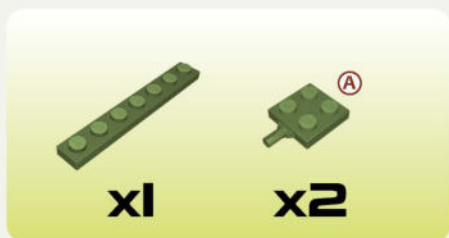
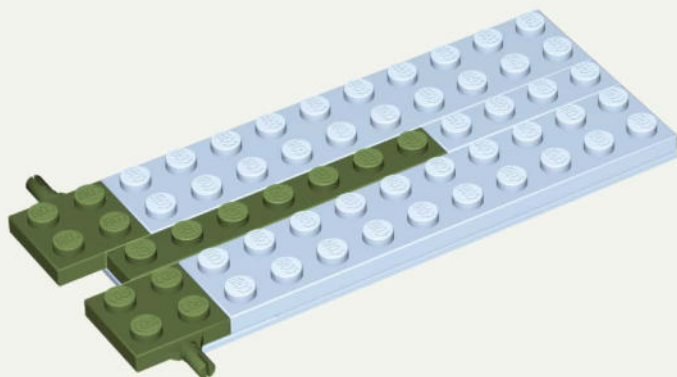

4

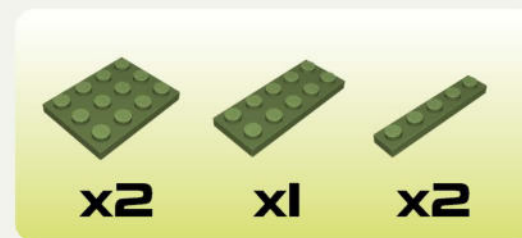
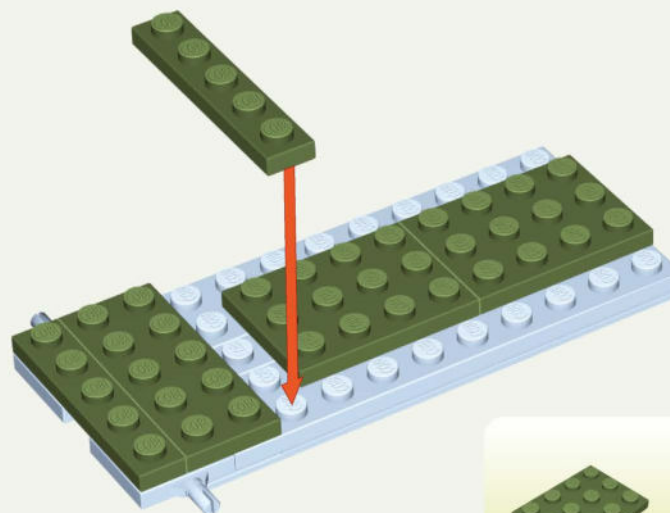

5

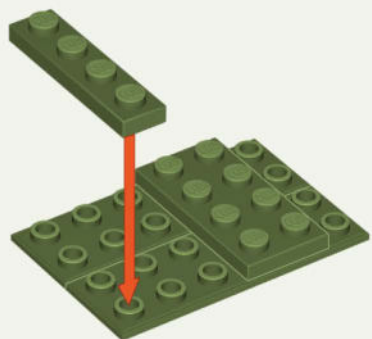

x2



x1



x1

6

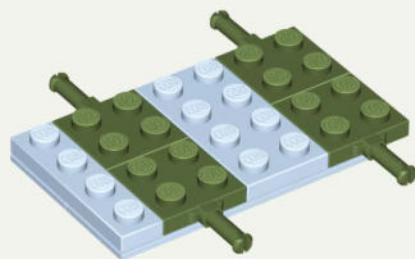

®

x4

7

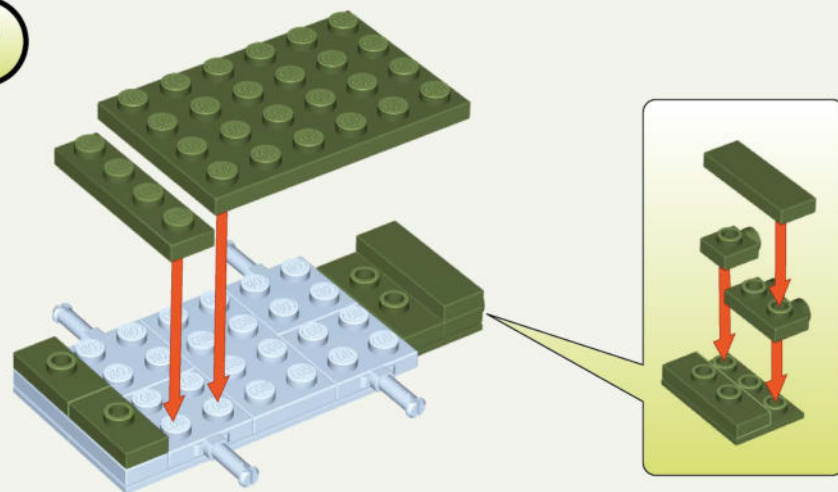

x1



x1



x1



x1



x1



x1



x2



x1

1:1

8

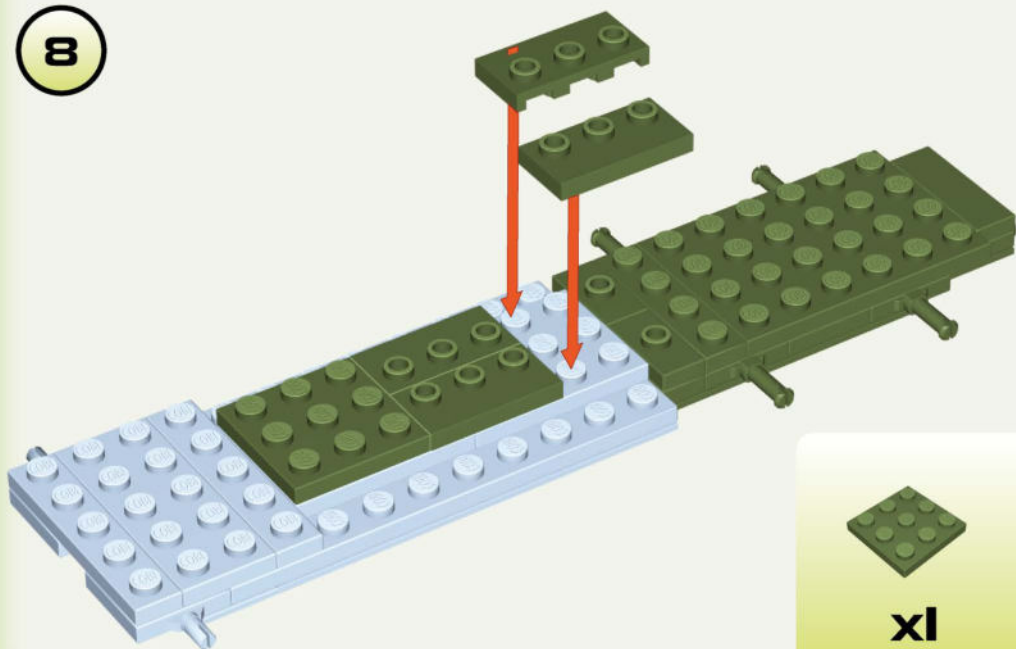

x1



x4

9

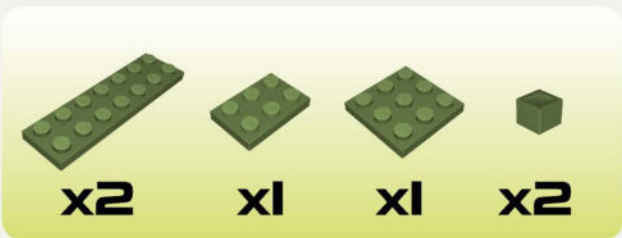
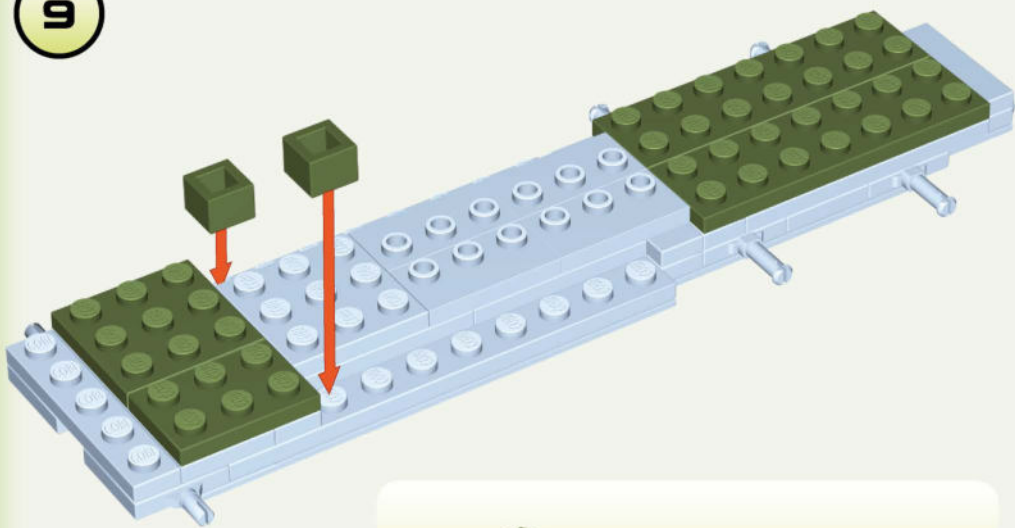

10

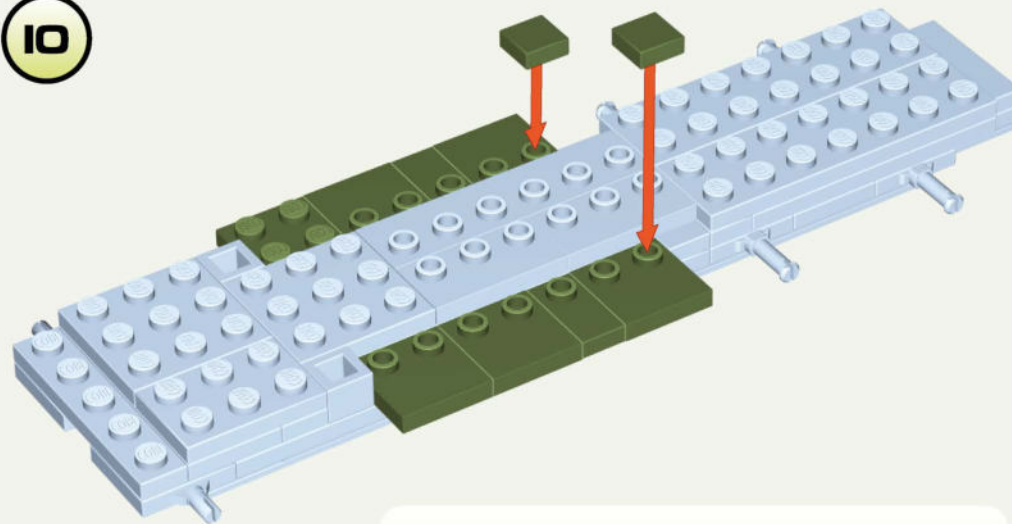



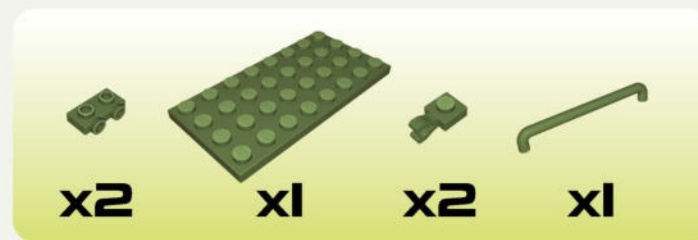
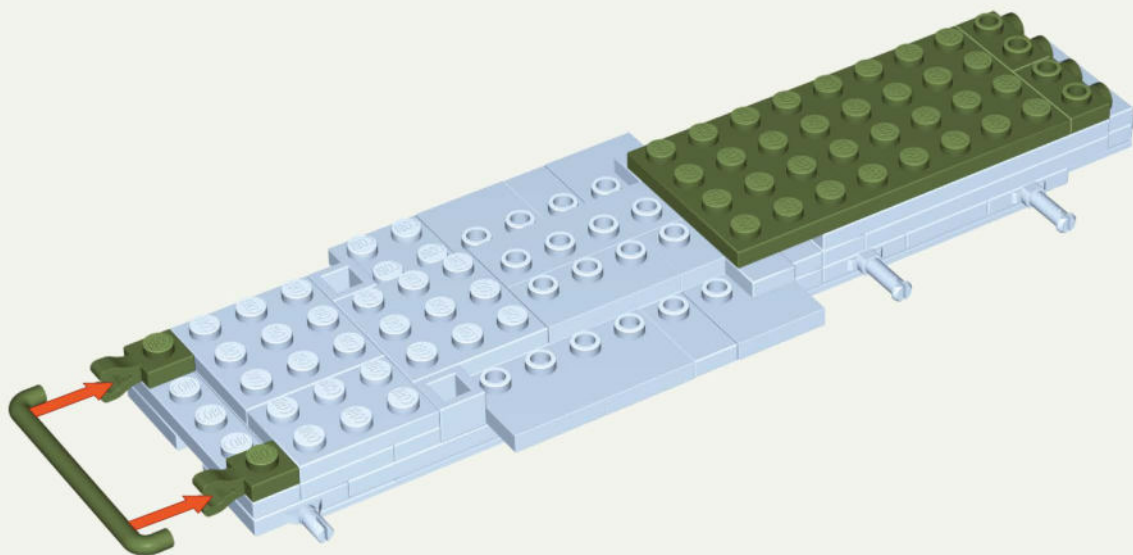

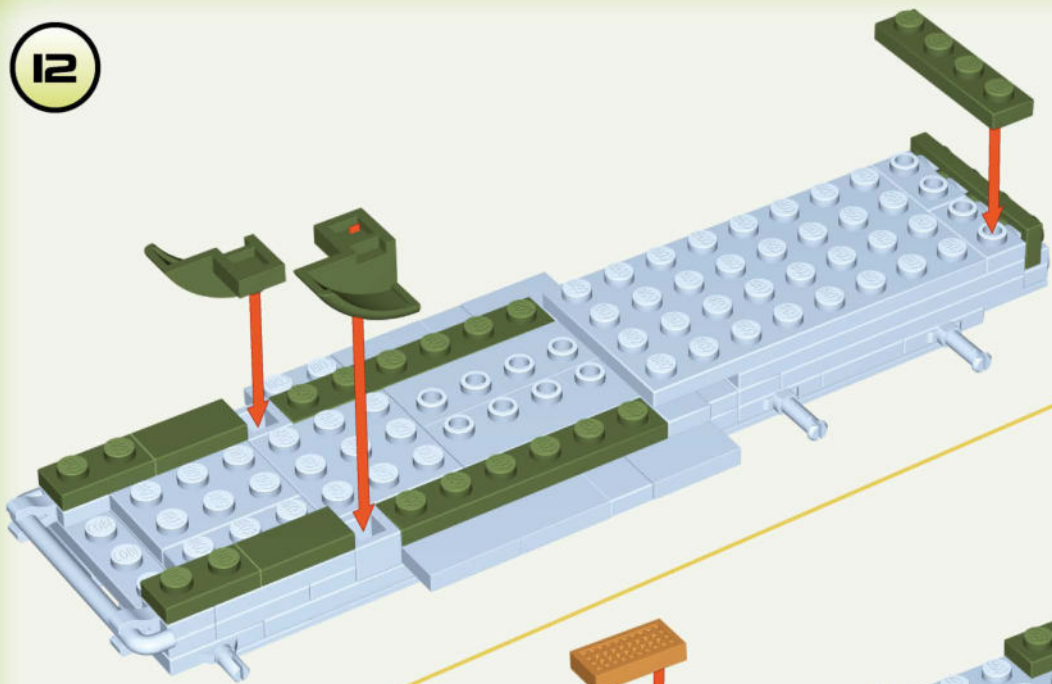

11



12







1:1

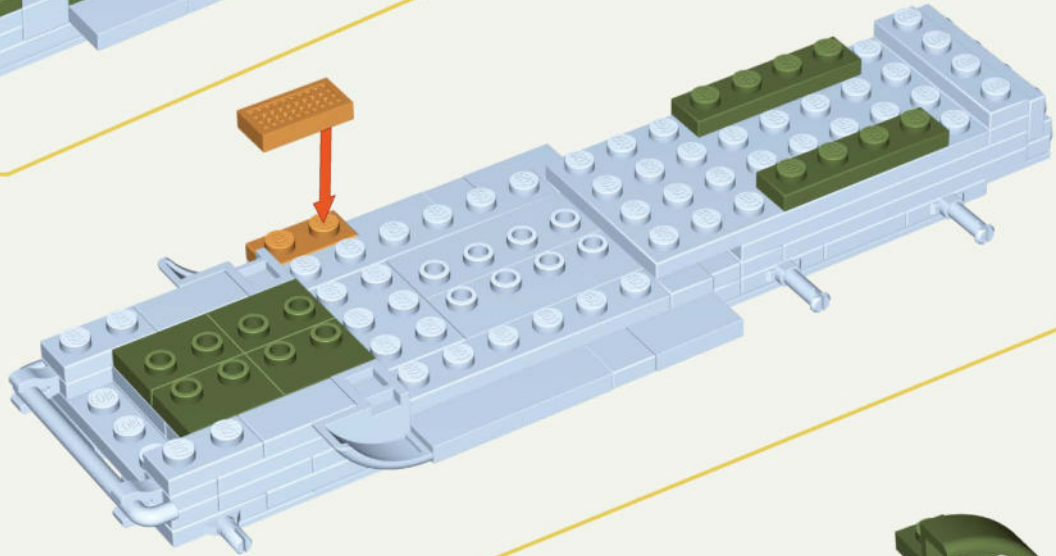







					
<b>x2</b>	<b>x2</b>	<b>x2</b>	<b>x2</b>	<b>x1</b>	<b>x1</b>

13



			
<b>x2</b>	<b>x4</b>	<b>x1</b>	<b>x1</b>

14

			
<b>x2</b>	<b>x2</b>	<b>x1</b>	<b>x2</b>
			
<b>x1</b>	<b>x1</b>	<b>x1</b>	<b>x1</b>

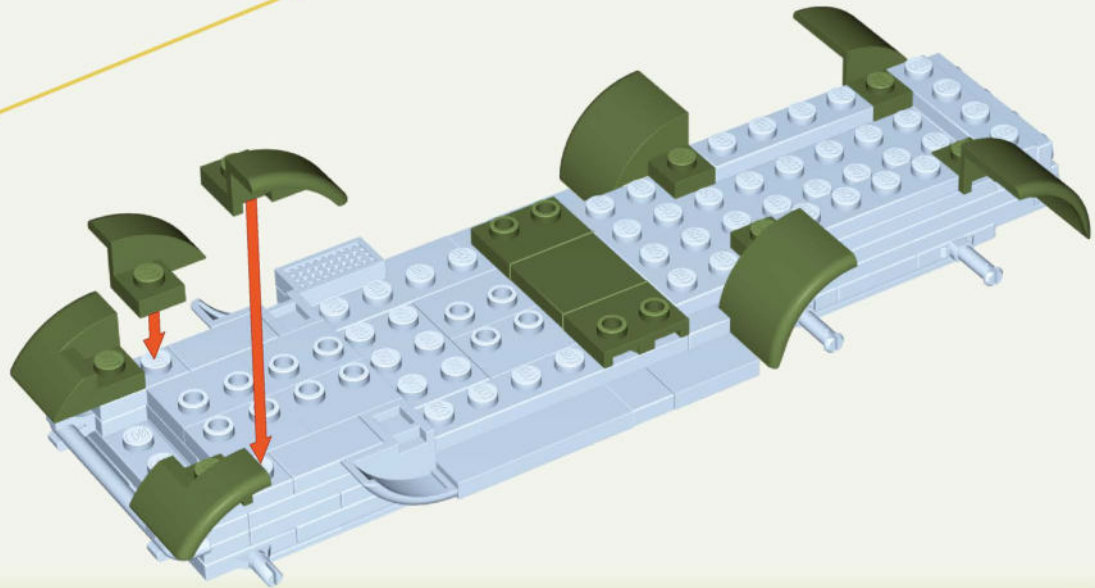

15

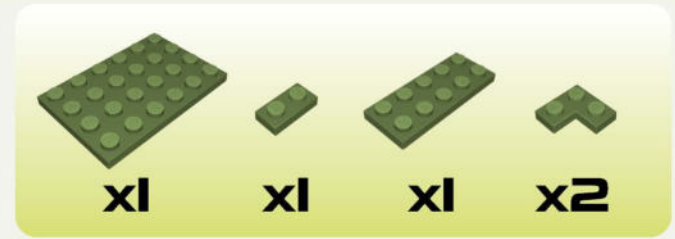
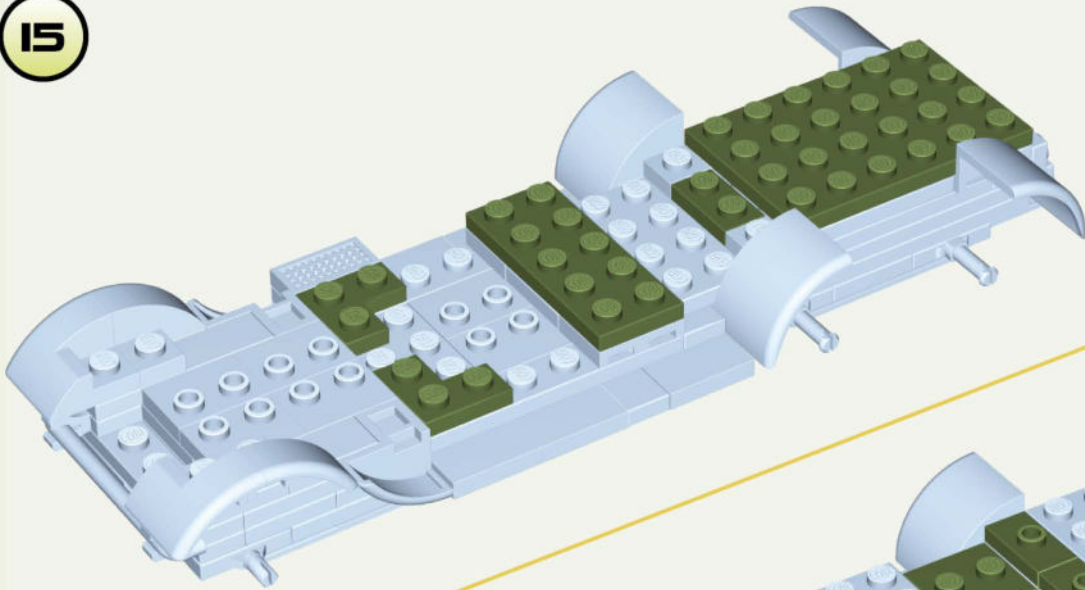

16

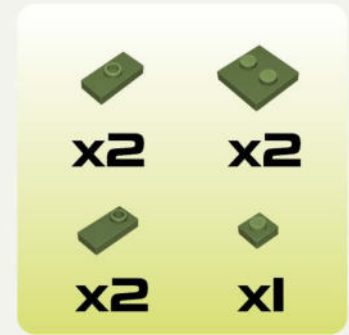
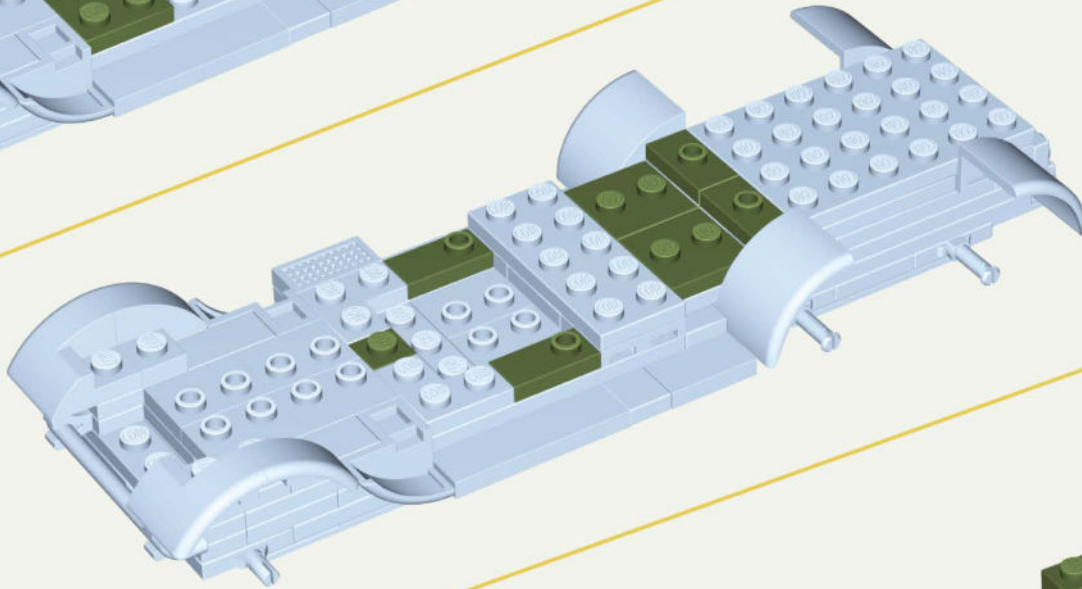



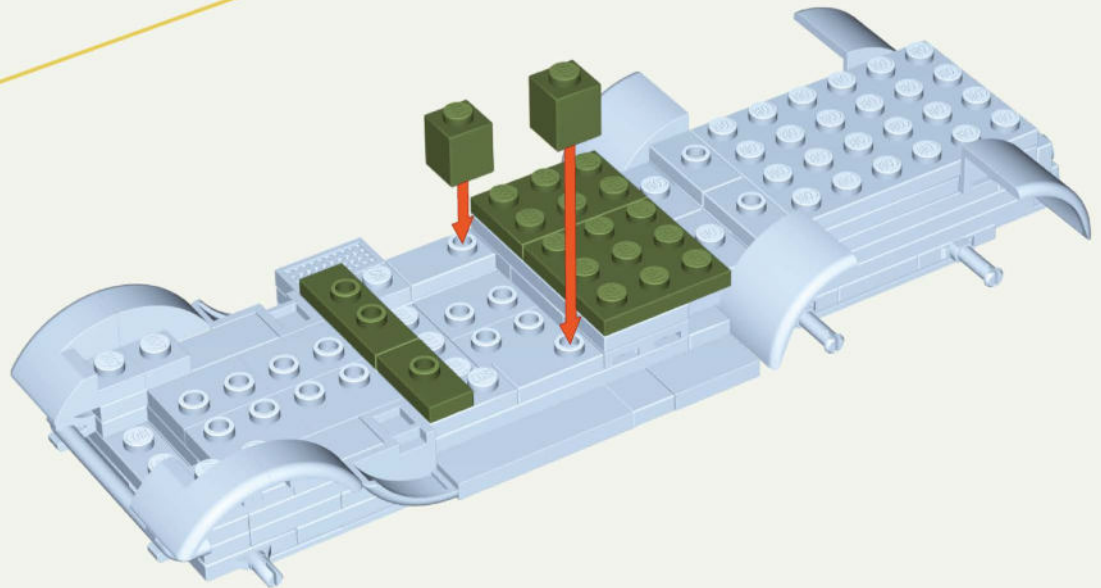
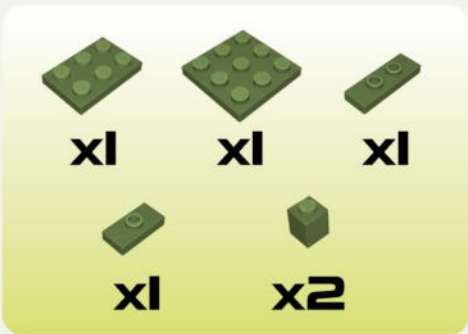

17

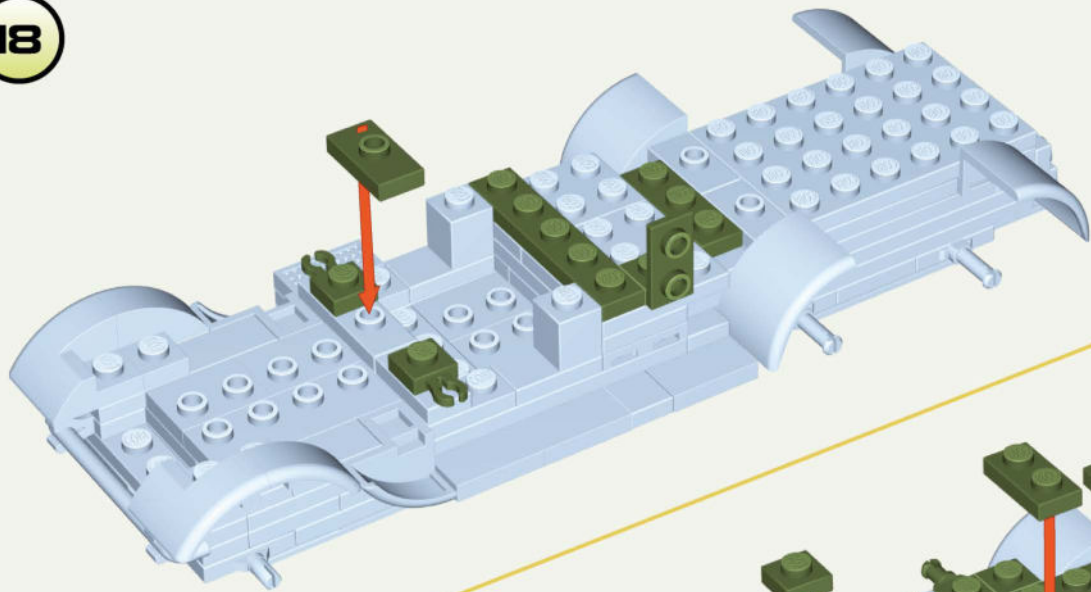







18

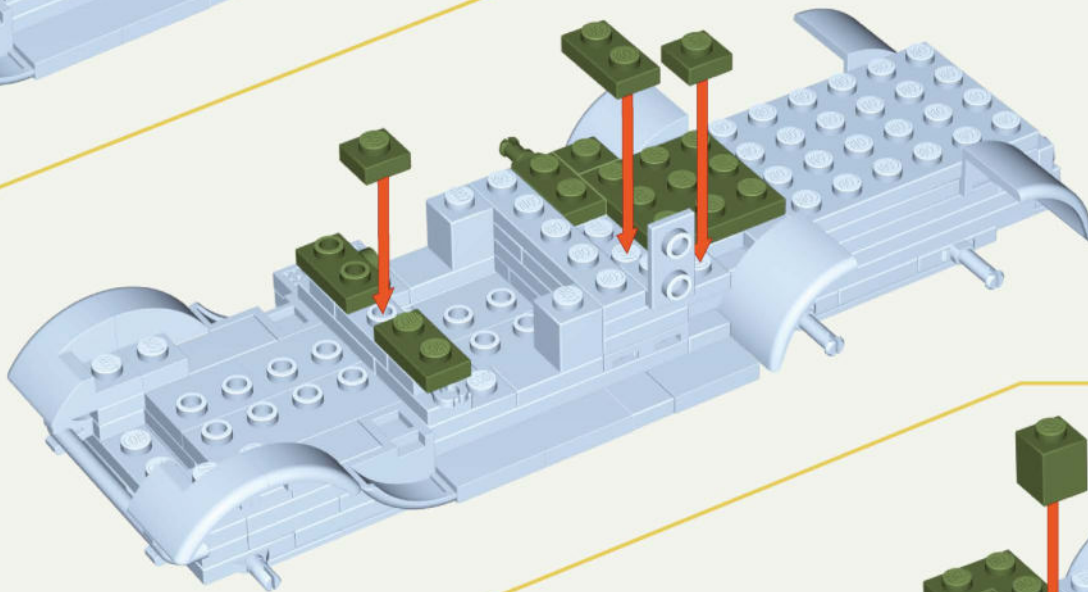

				
<b>x1</b>	<b>x1</b>	<b>x1</b>	<b>x2</b>	<b>x1</b>

19



		
<b>x1</b>	<b>x1</b>	<b>x1</b>
		
<b>x2</b>	<b>x3</b>	

20

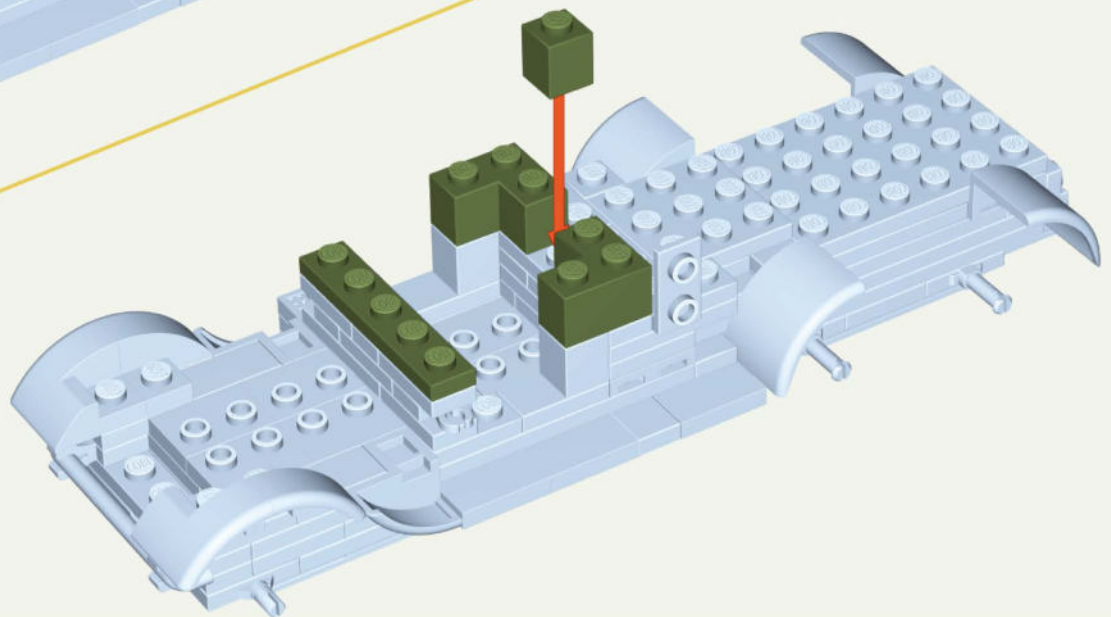

		
<b>x1</b>	<b>x2</b>	<b>x1</b>

21

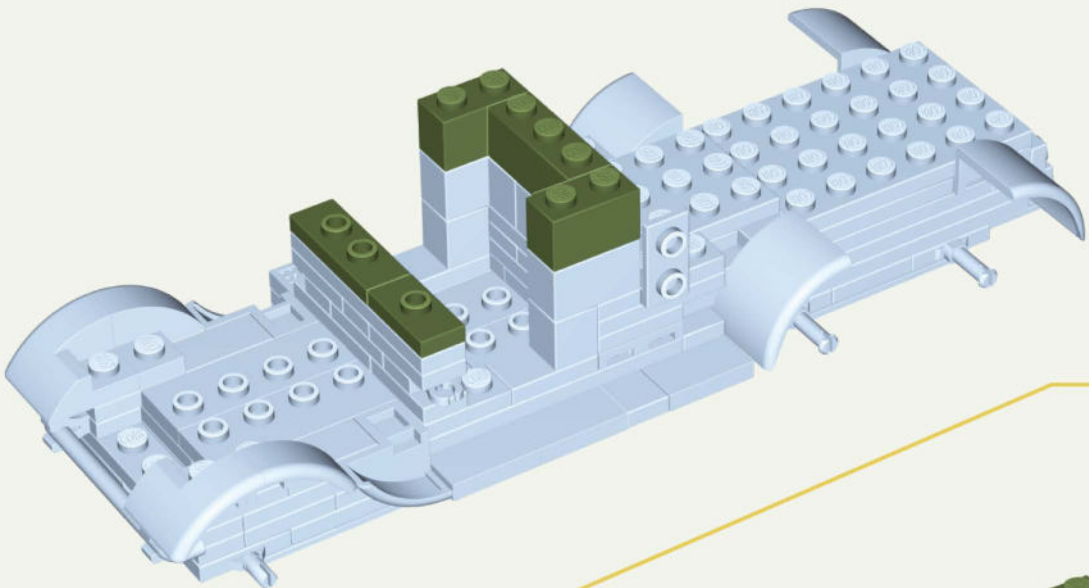
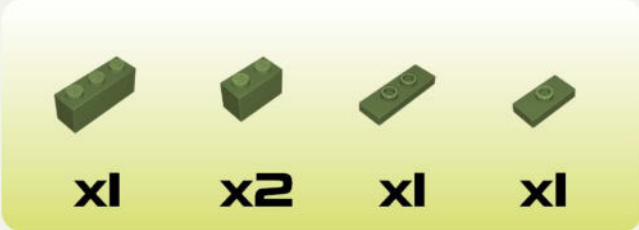



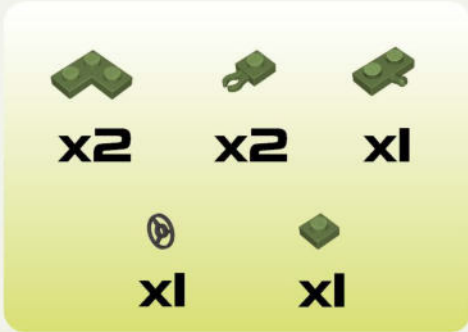
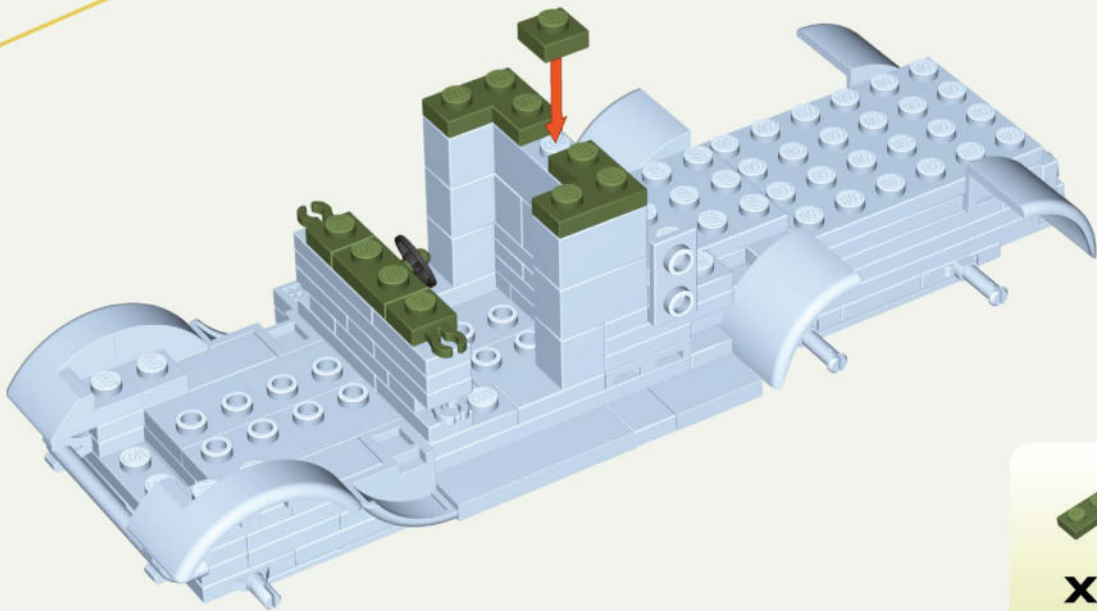
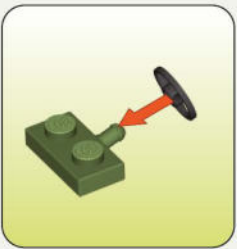





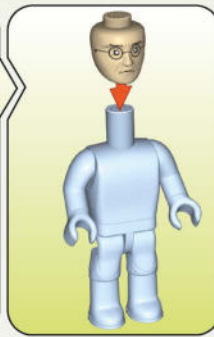
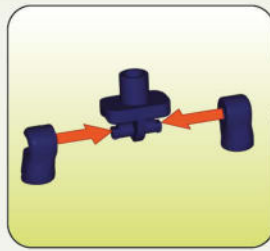

22





23



-  x1
-  x1
-  x1
-  x2
-  x1
-  x1
-  x1
-  x1
-  x2

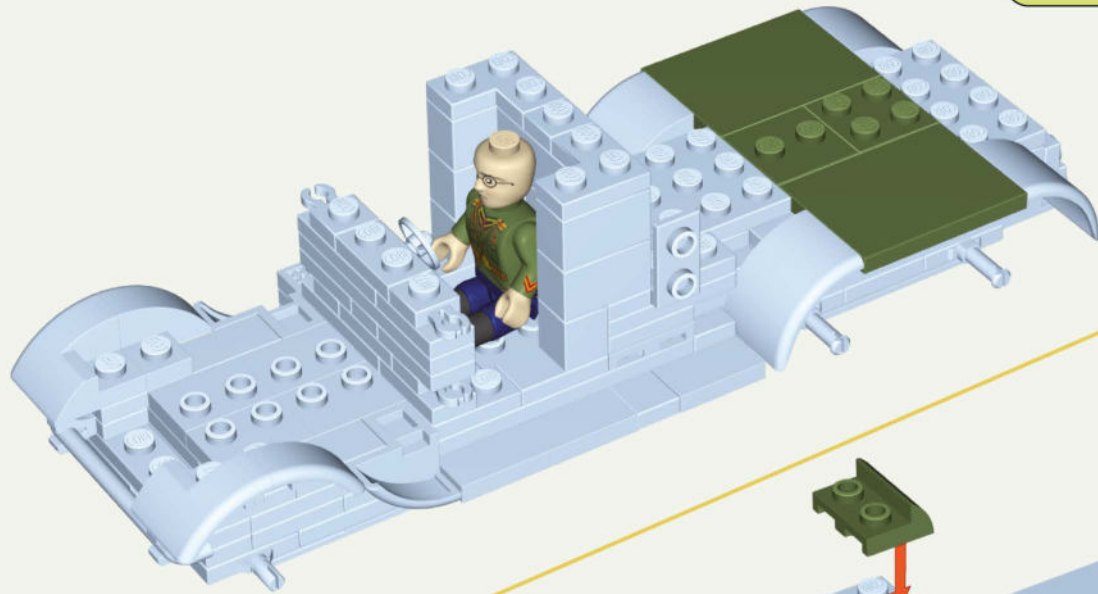

24

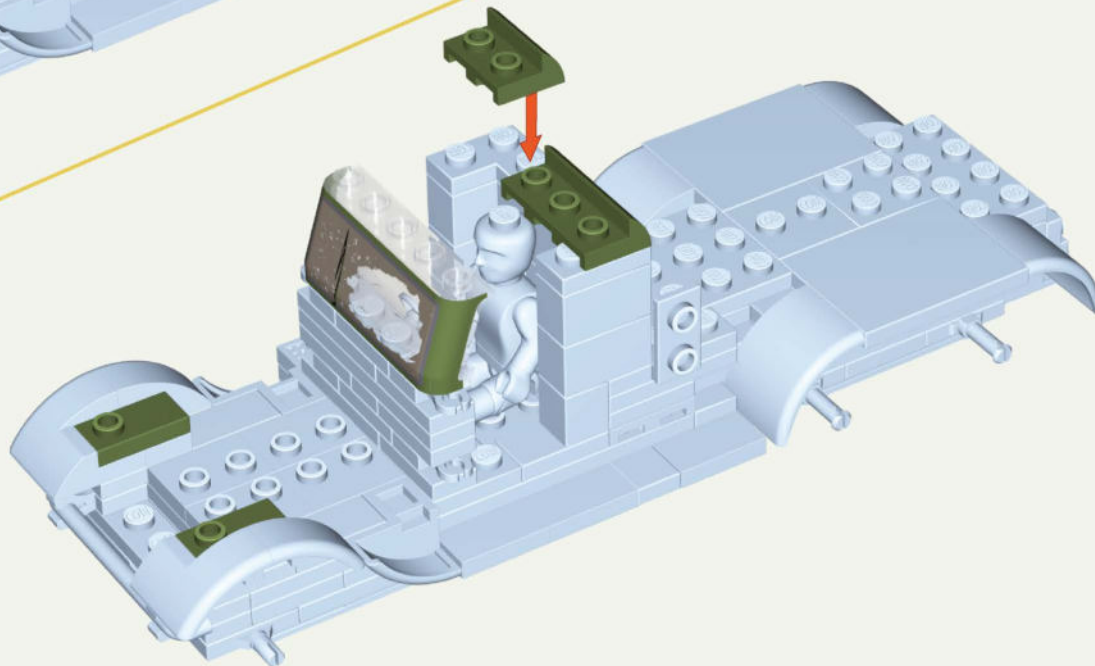

-  x2
-  x1
-  x1
-  x1

25

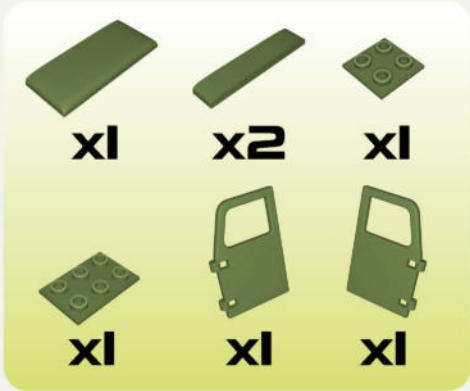
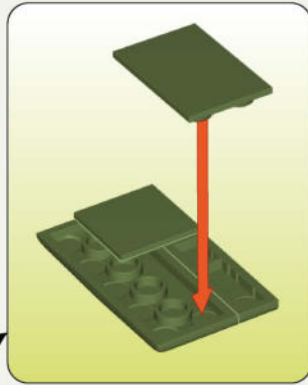
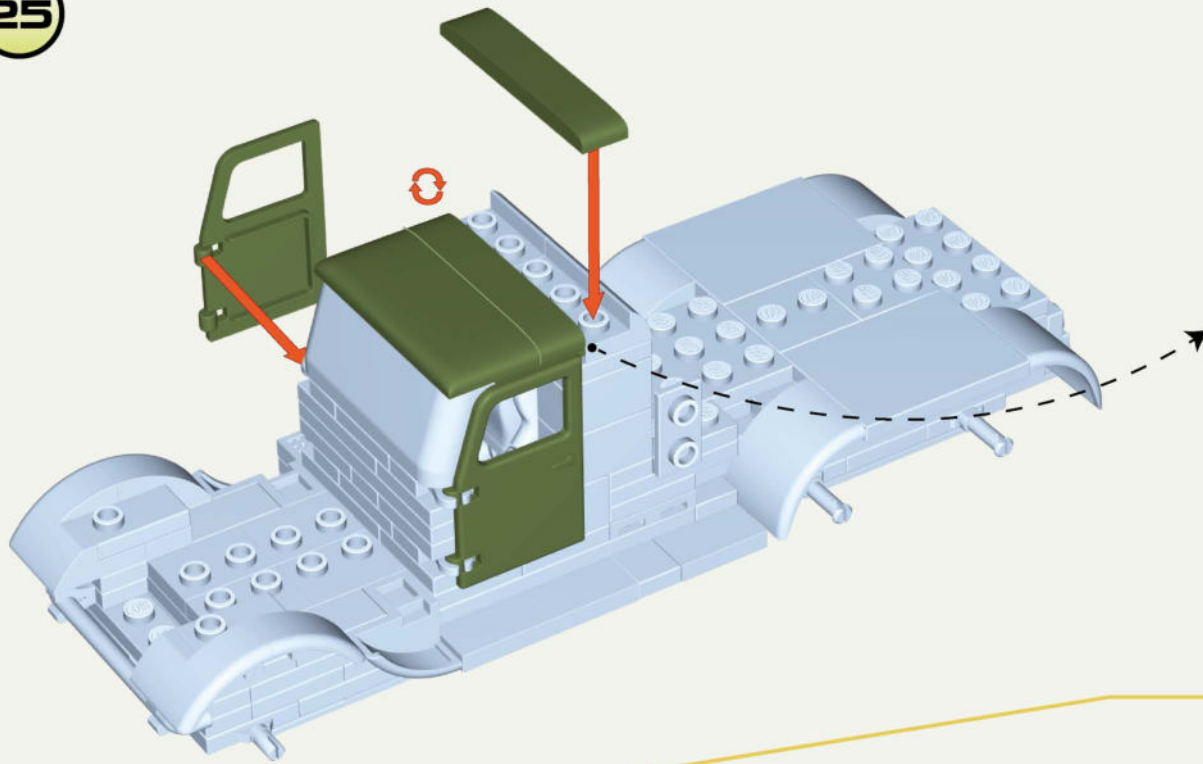

26

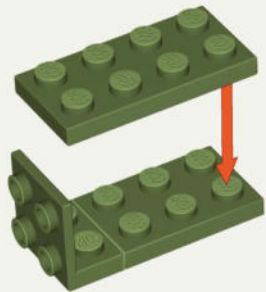

27

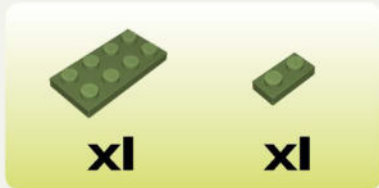
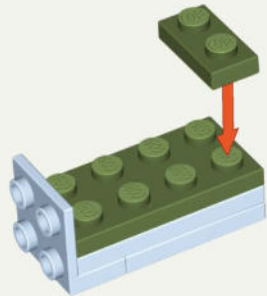

28

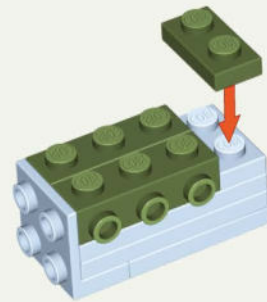

29

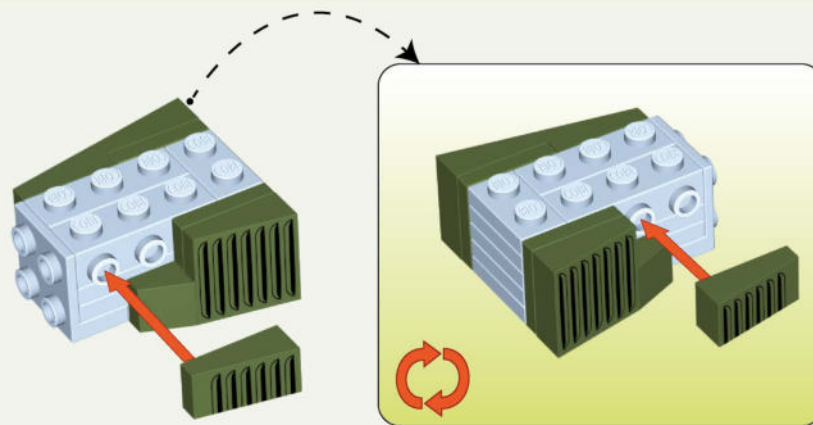
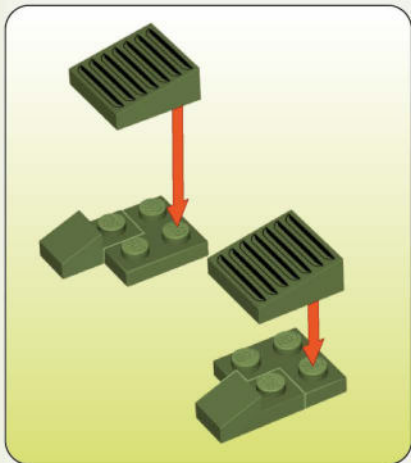

30

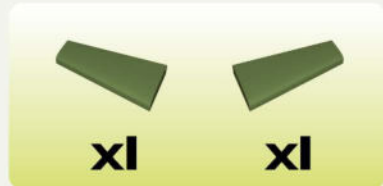
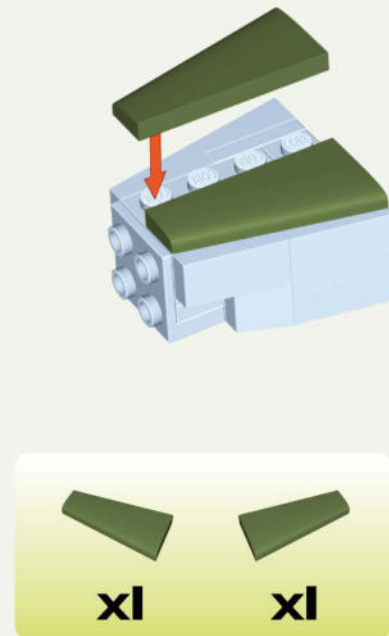

31

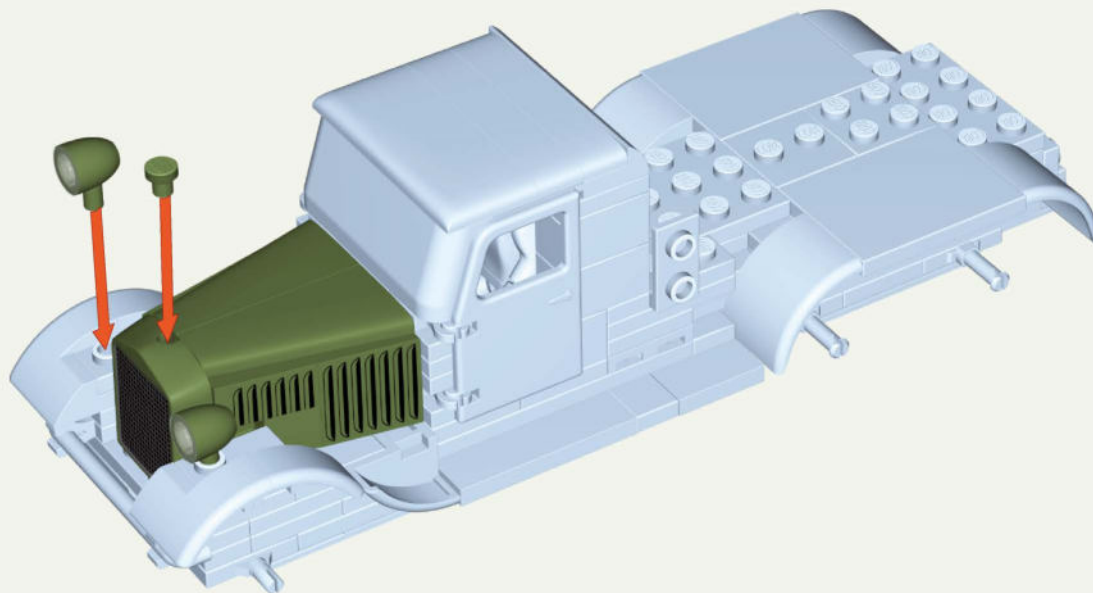

32

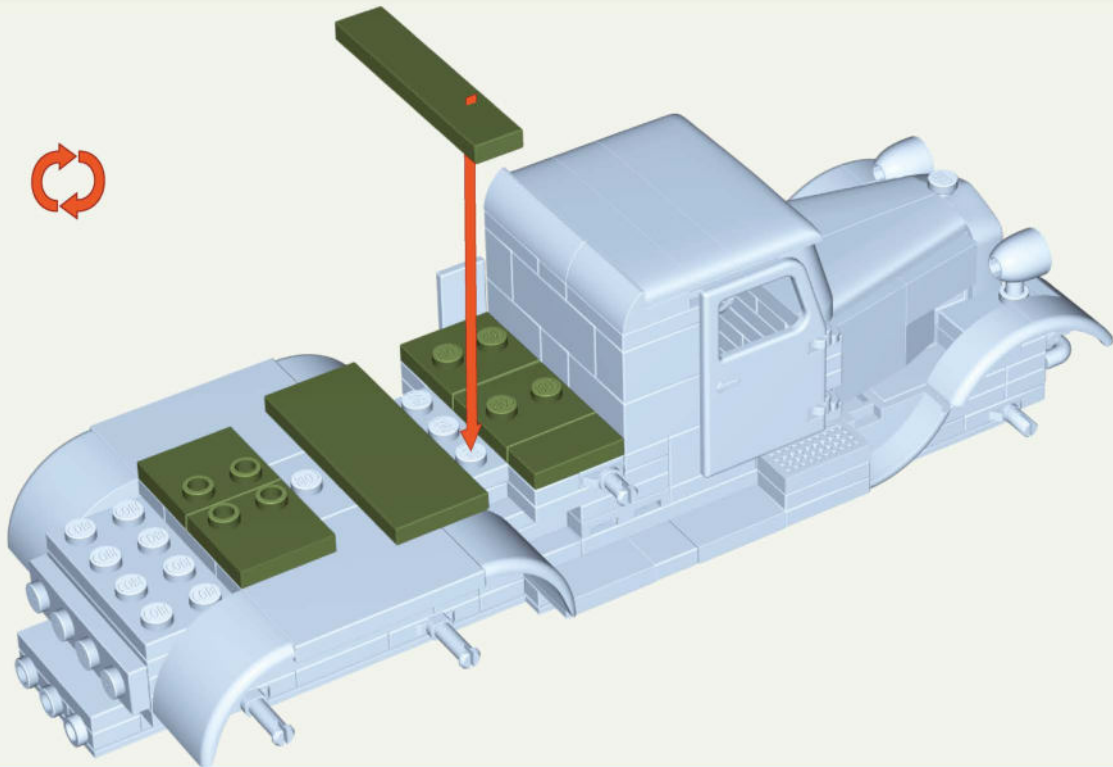





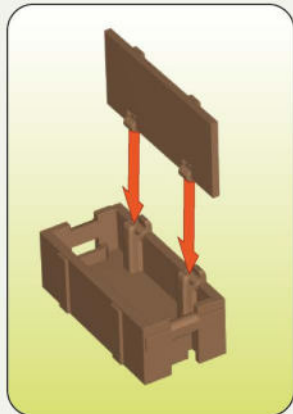
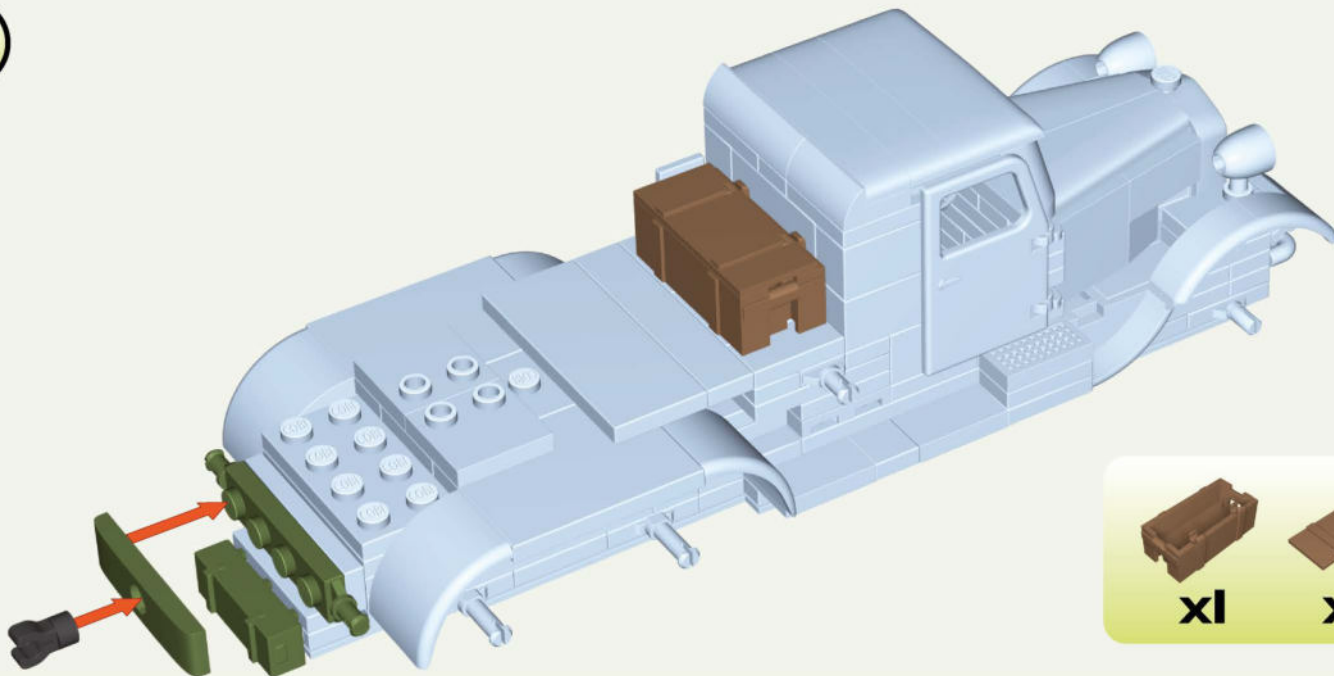

1:1		1:1		
<b>x2</b>	<b>x1</b>	<b>x1</b>	<b>x2</b>	<b>x1</b>

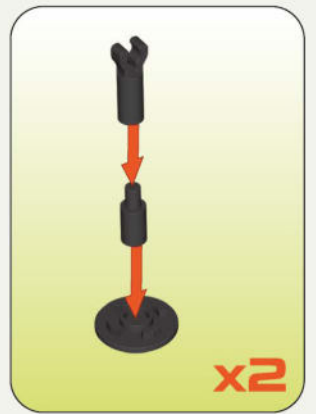
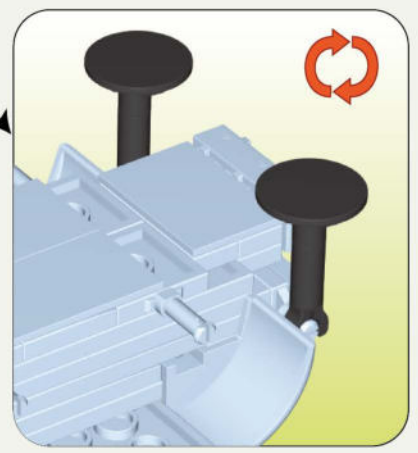
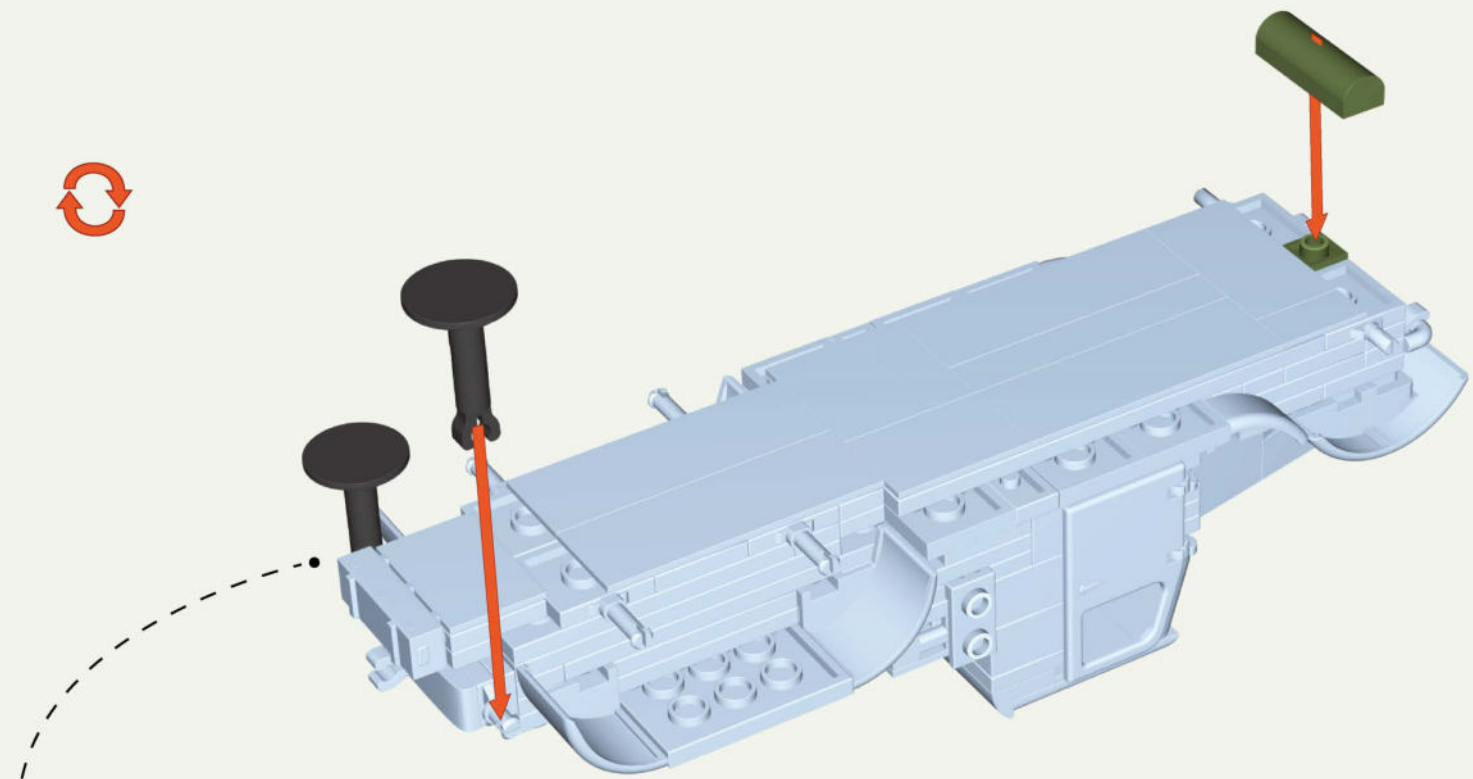
33



<b>x1</b>	<b>x1</b>	<b>x1</b>	<b>x1</b>	<b>x1</b>	<b>x1</b>



-  x1
-  x1
-  x2
-  x2
-  x2

35



2

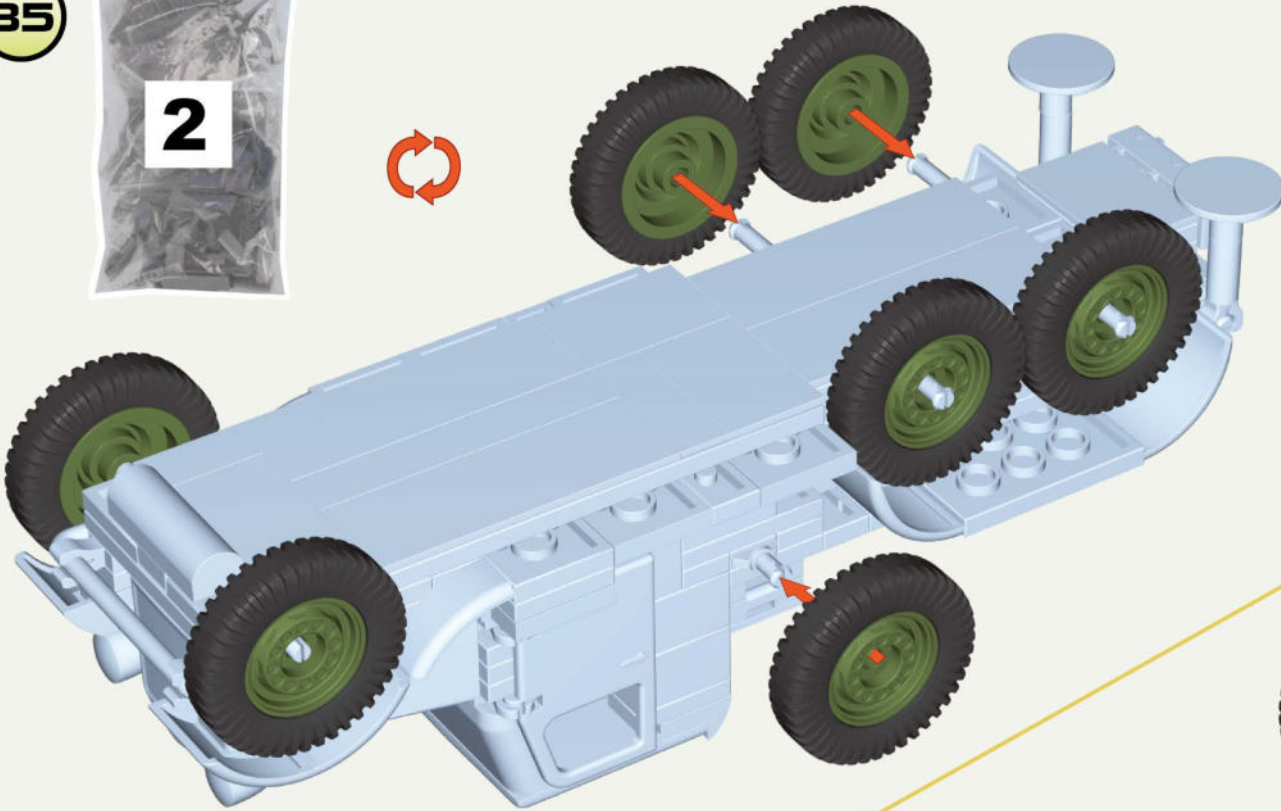

36

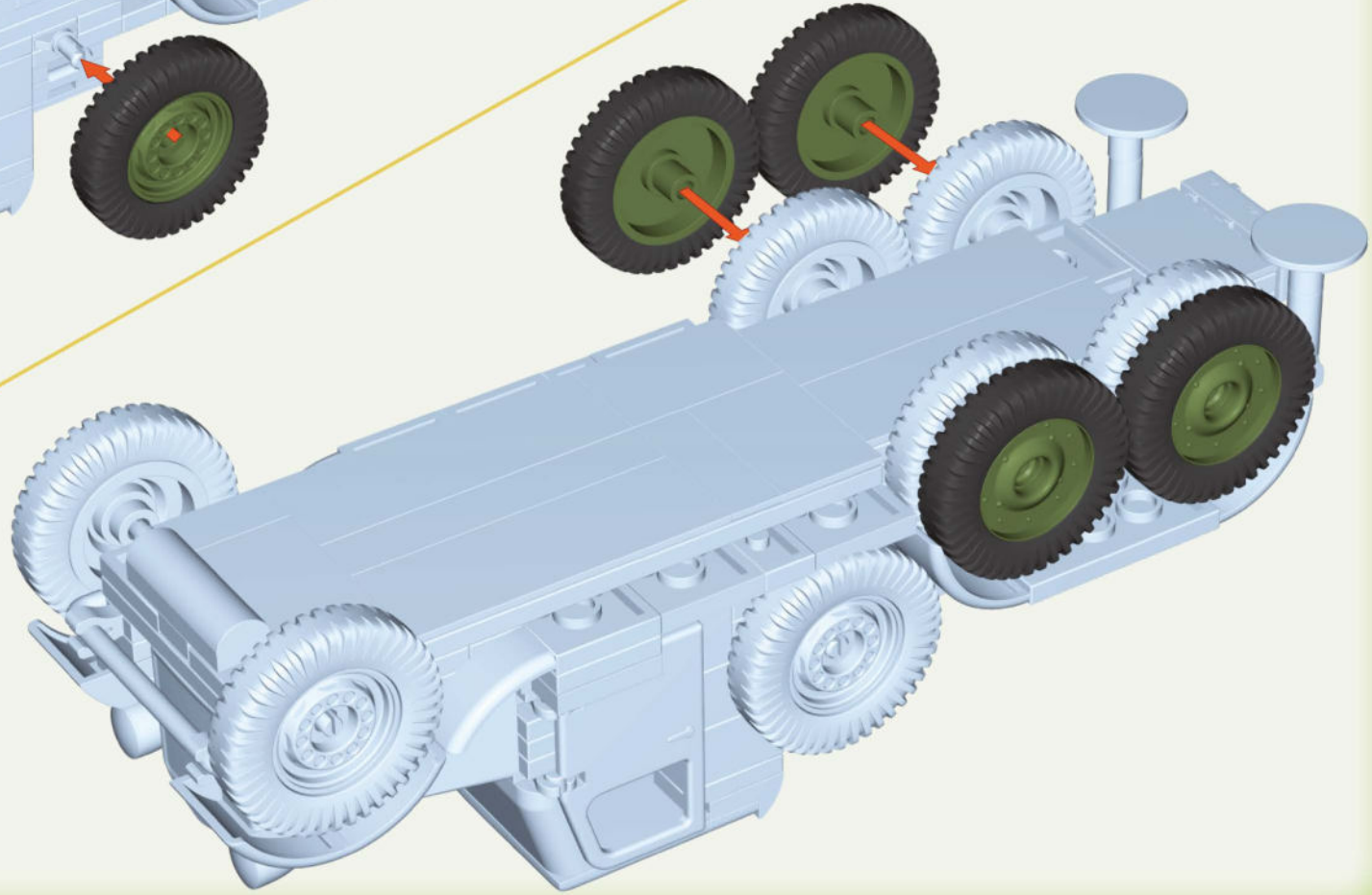

37

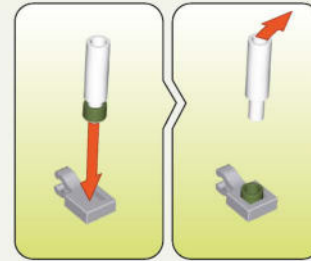
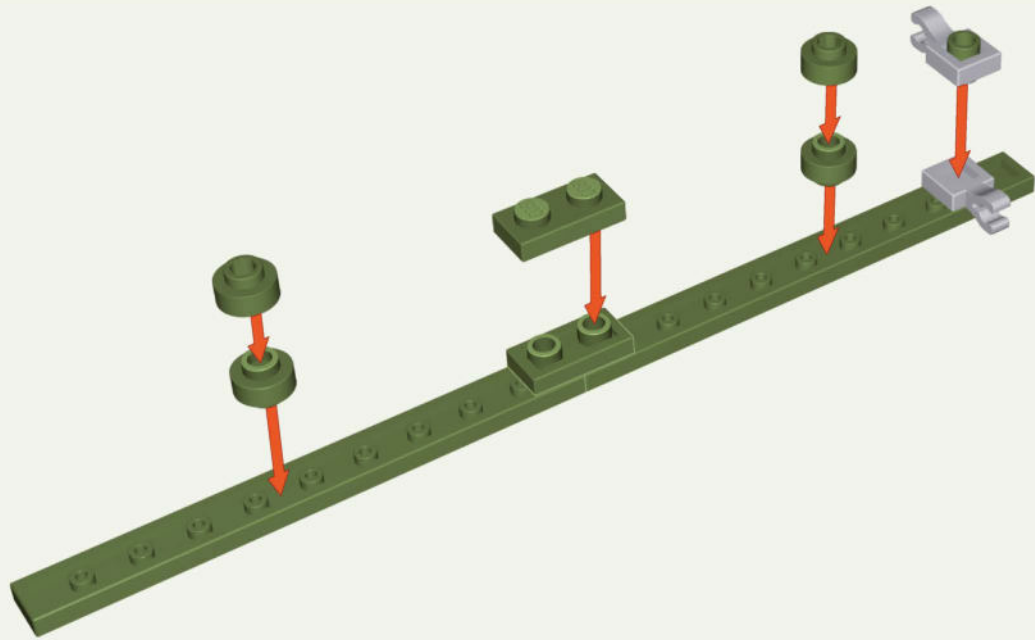

1:1

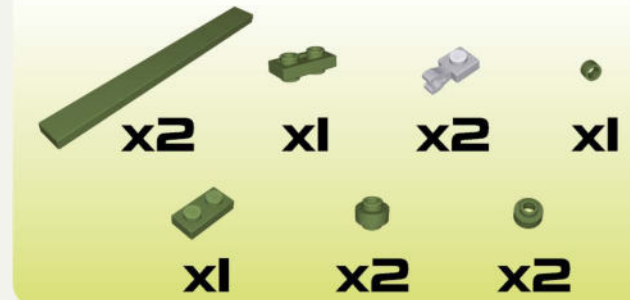

38

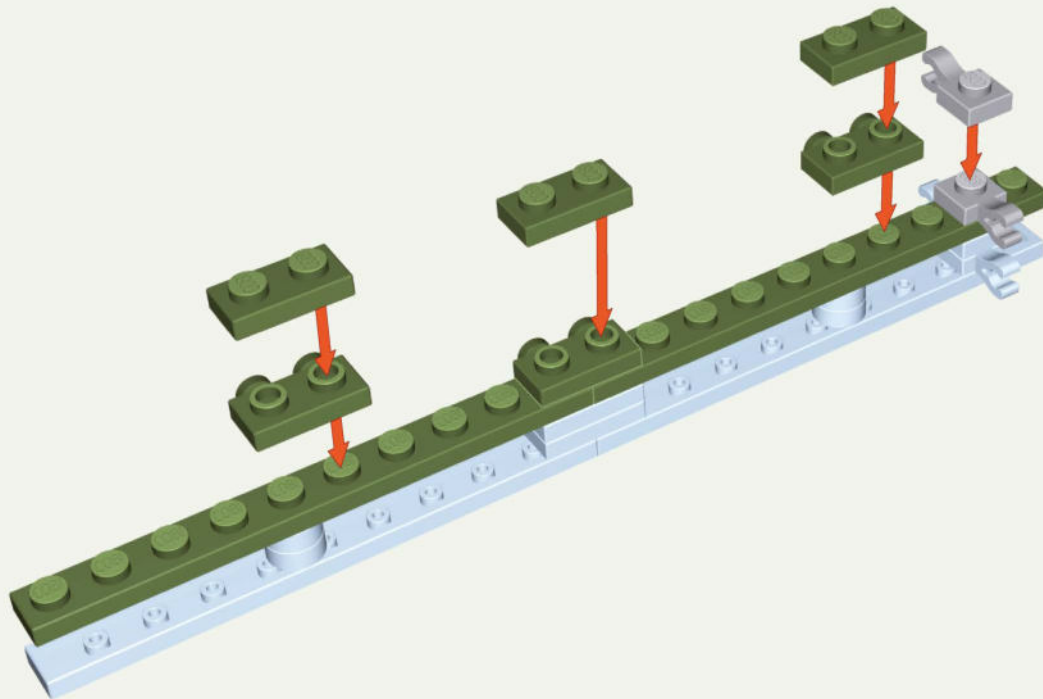

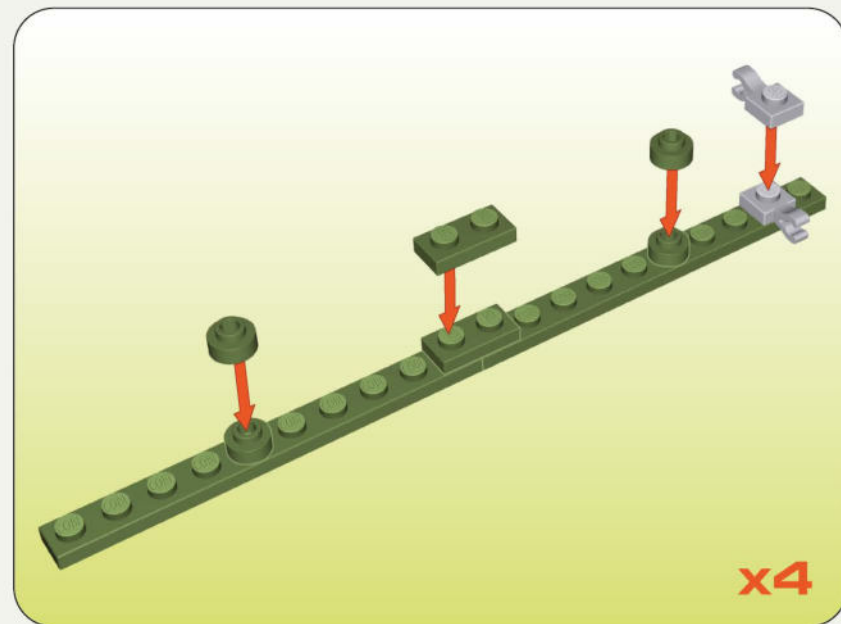
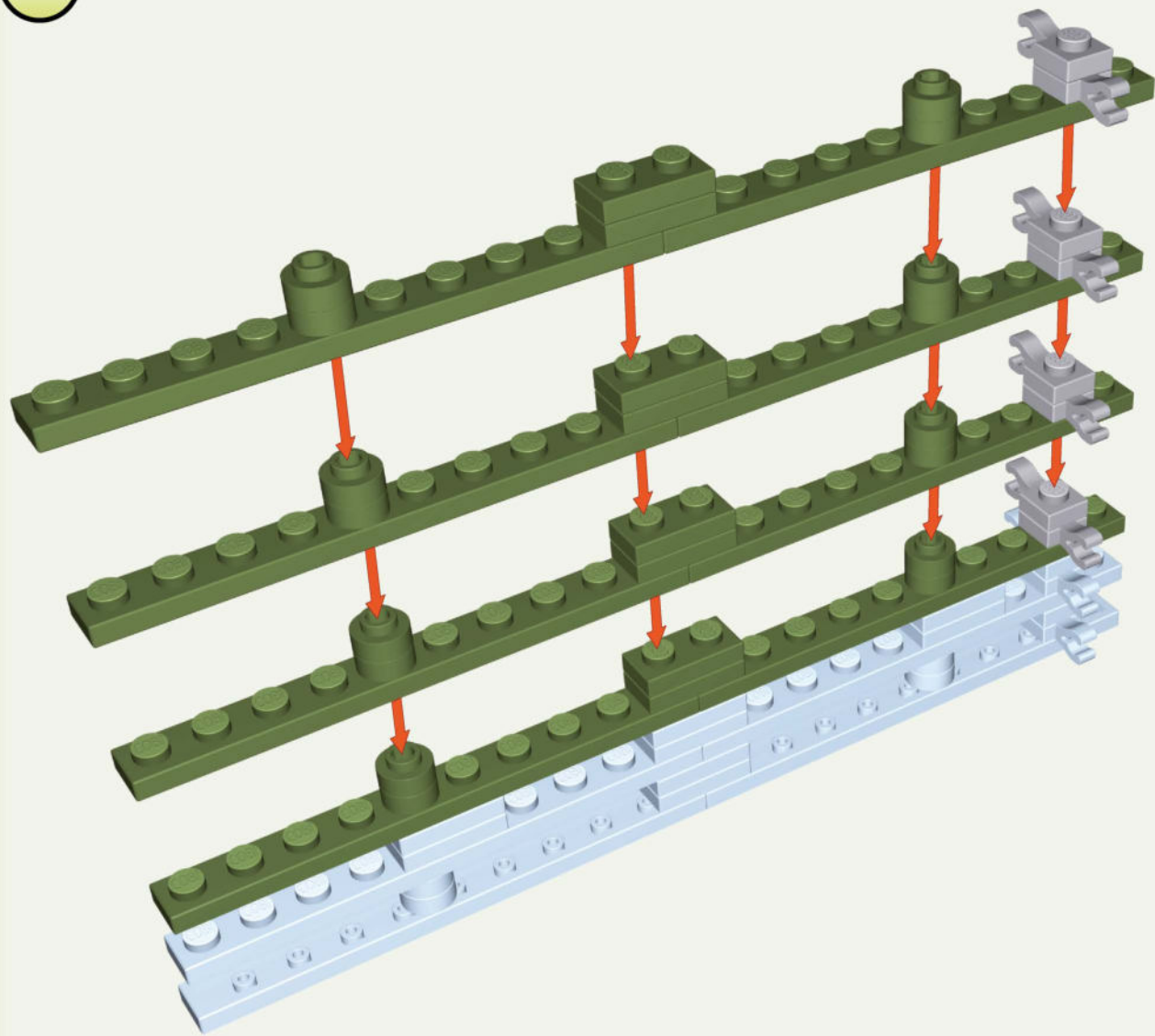

-  x8
-  x16
-  x8
-  x8



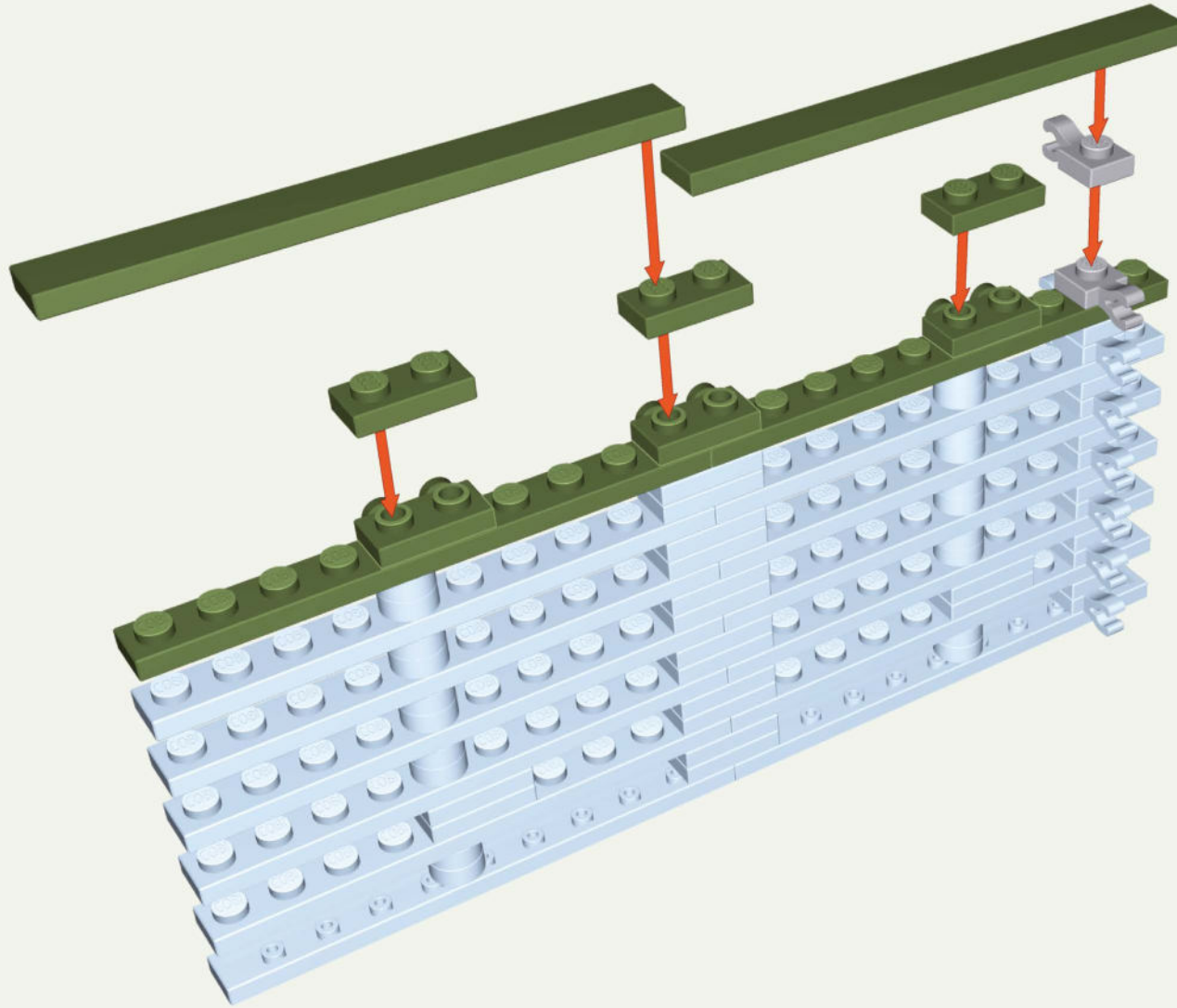

1:1



41

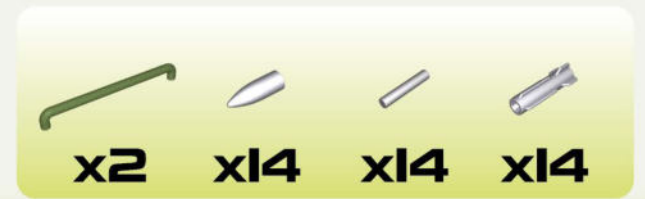
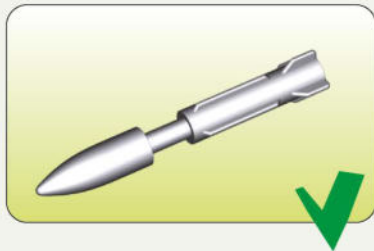
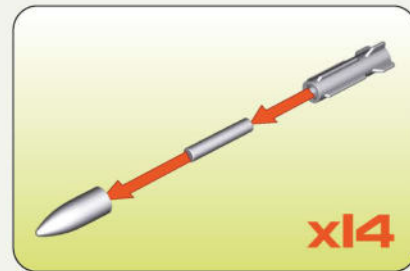
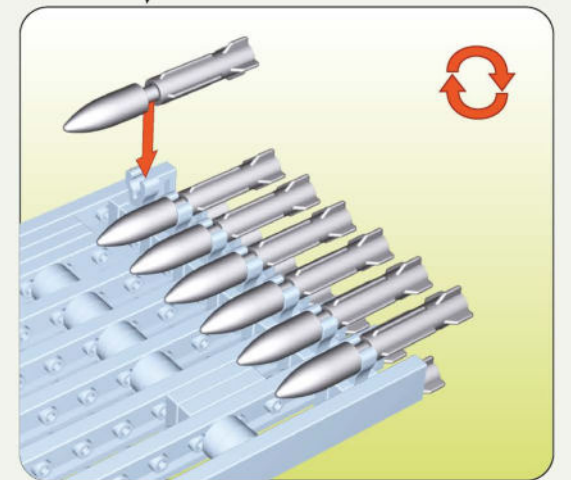
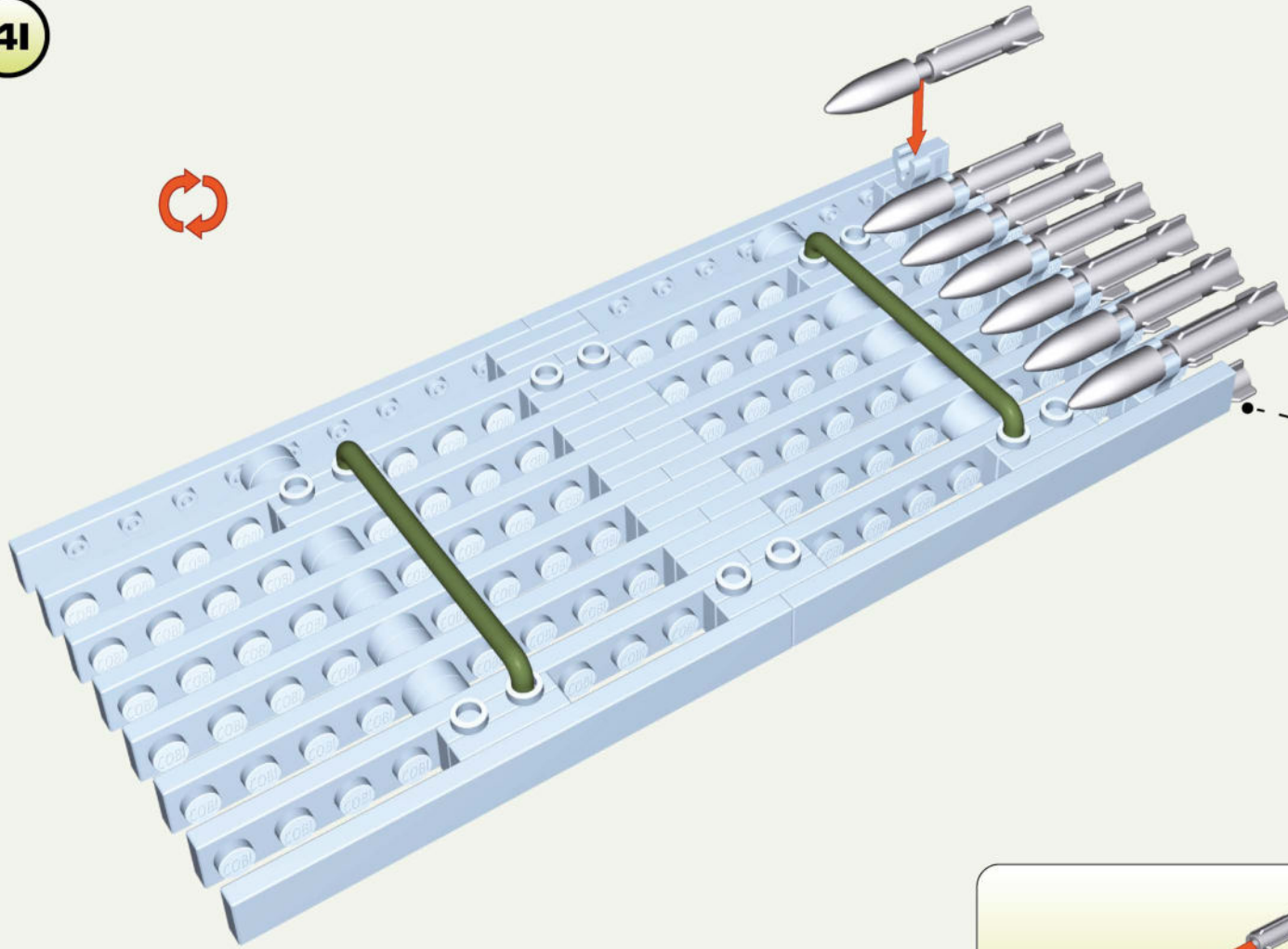

42

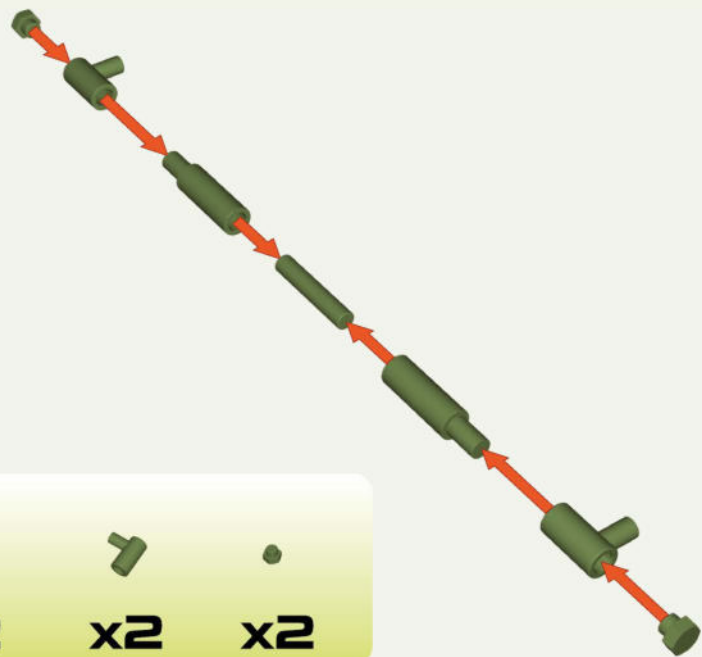

- x1
- x2
- x2
- x2

43

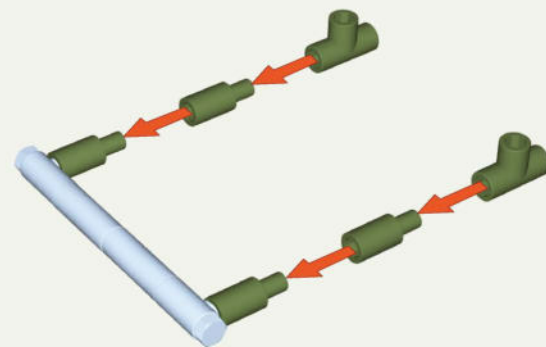

- x4
- x2

44

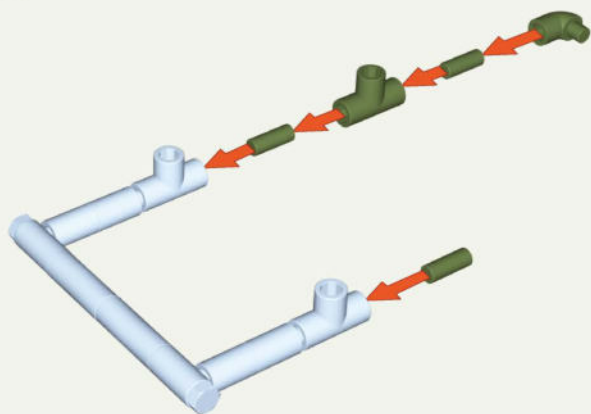

- x3
- x1
- x1

45

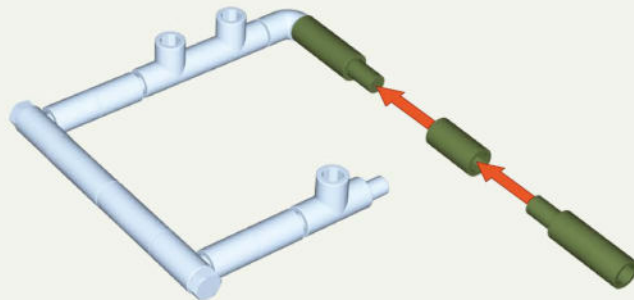

- x2
- x1

46

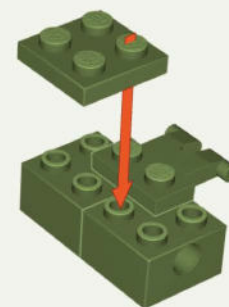

- x2
- x1
- x1

47

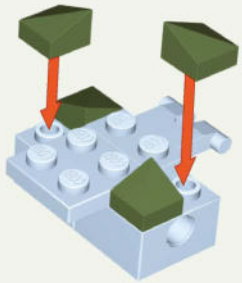

48

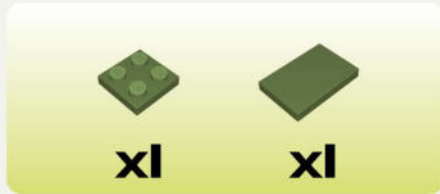
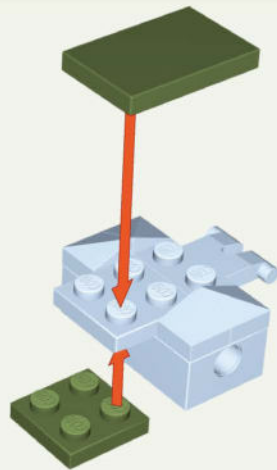

49

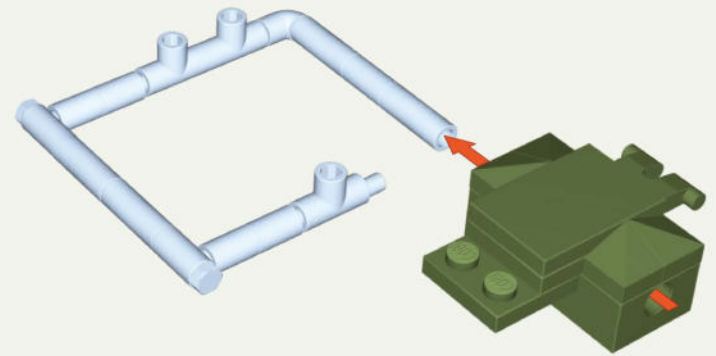

50

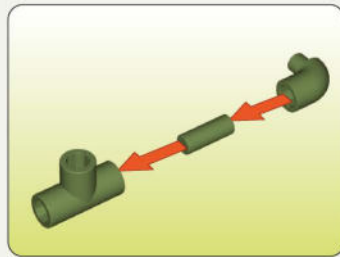
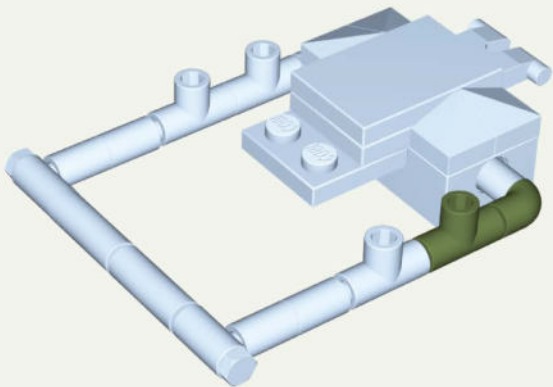

51

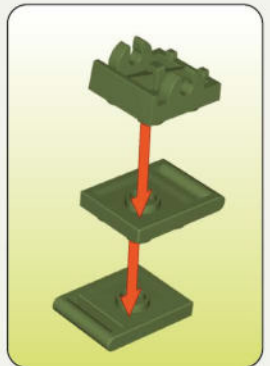
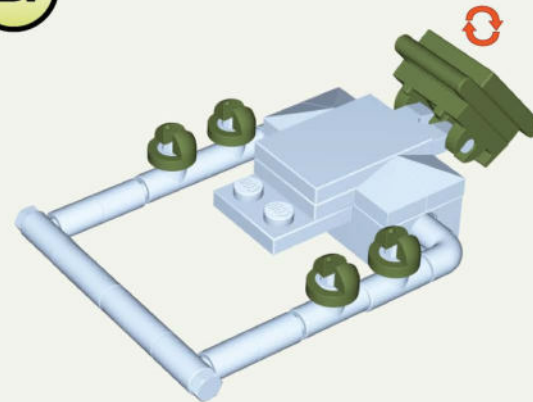

52

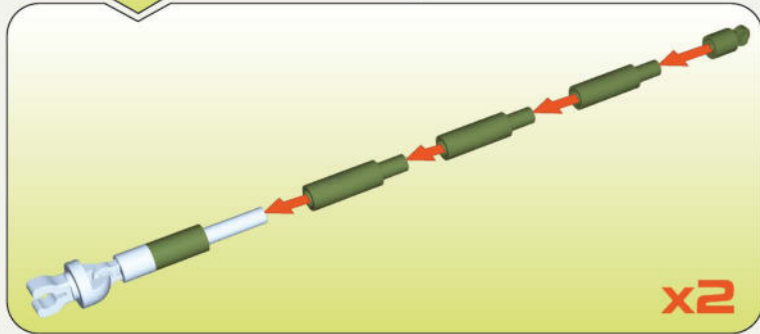
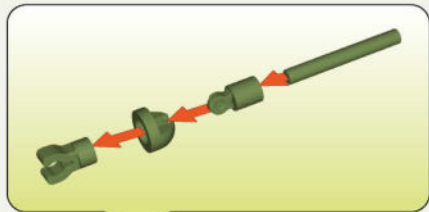

-   
**x2**
-   
**x2**
-   
**x4**
-   
**x2**
-   
**x2**
-   
**x6**

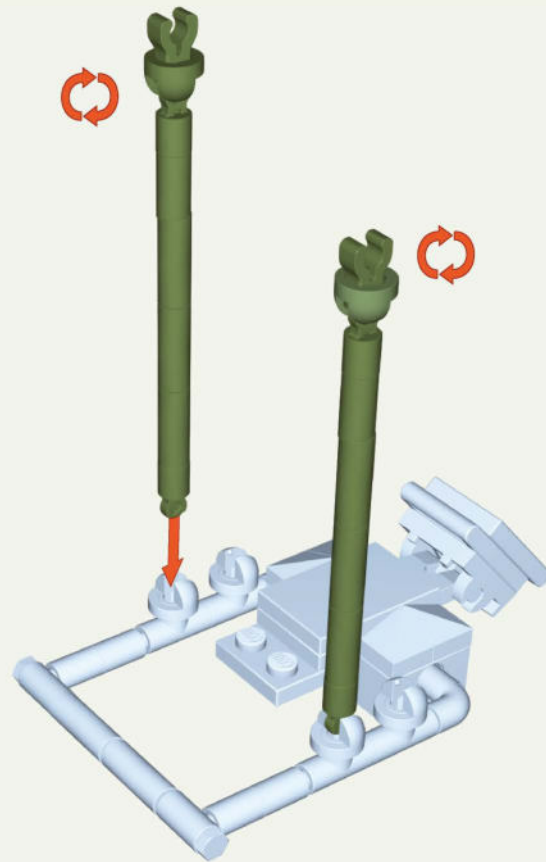

53

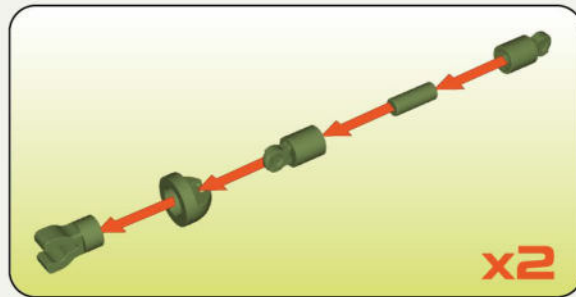
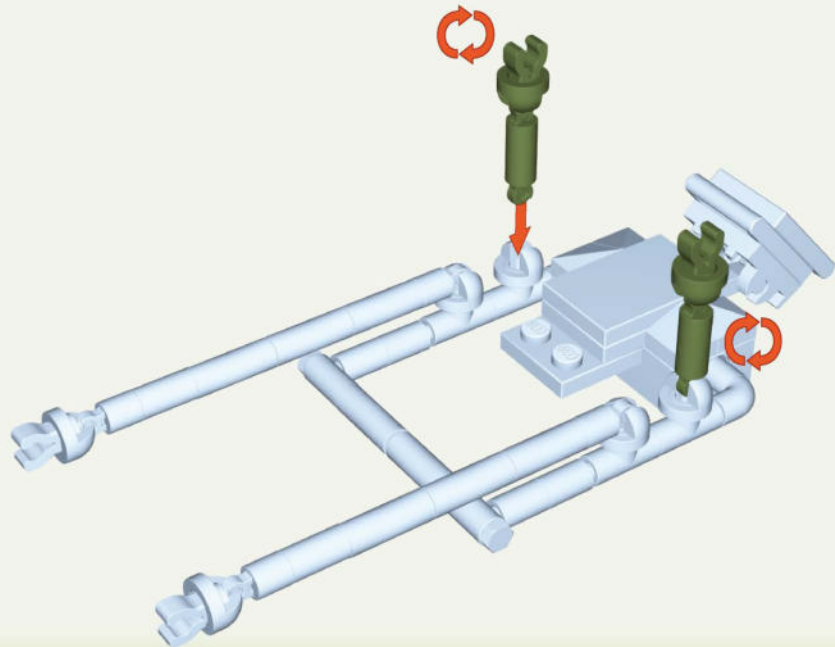

-   
**x2**
-   
**x2**
-   
**x4**
-   
**x2**

54

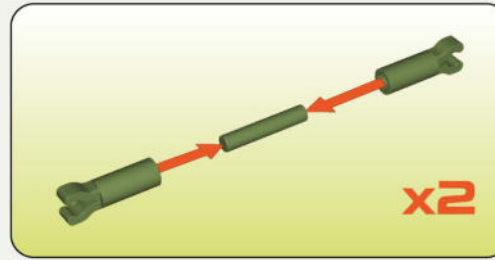
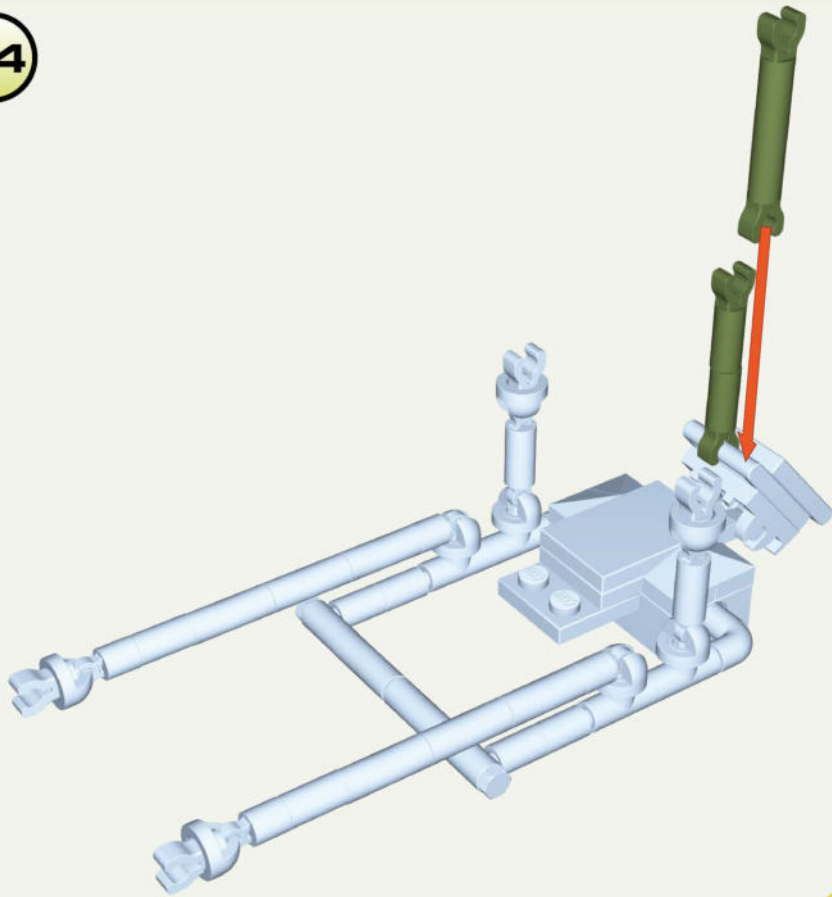

55

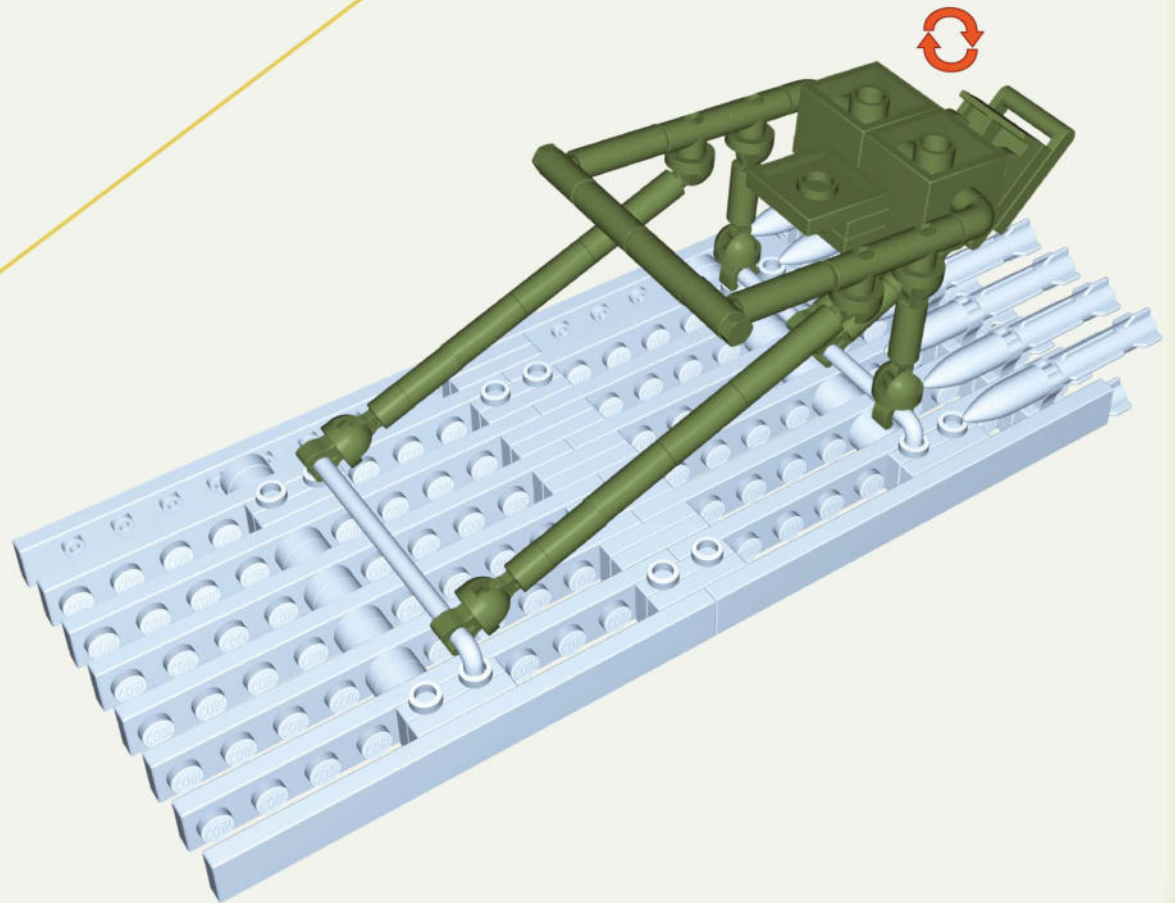
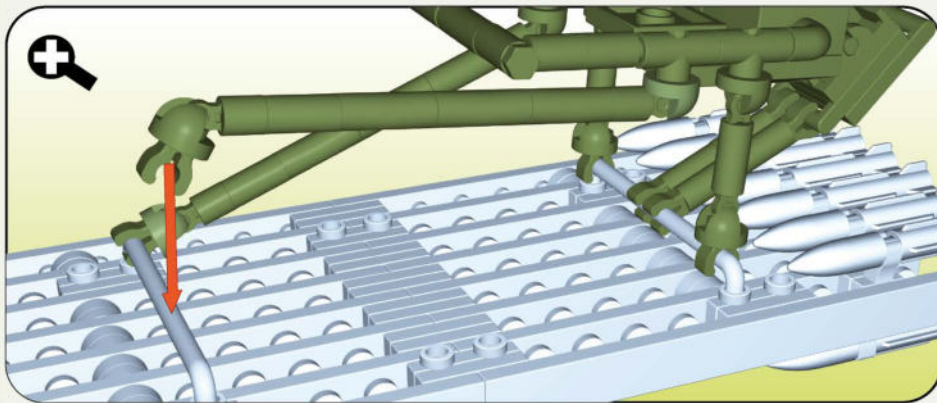

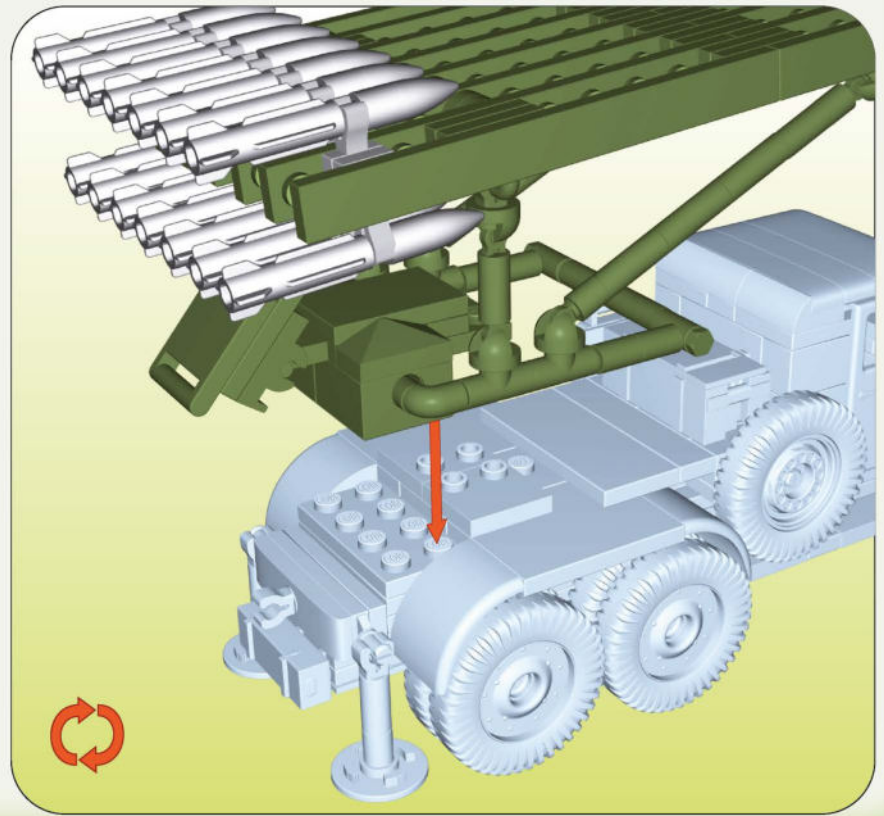
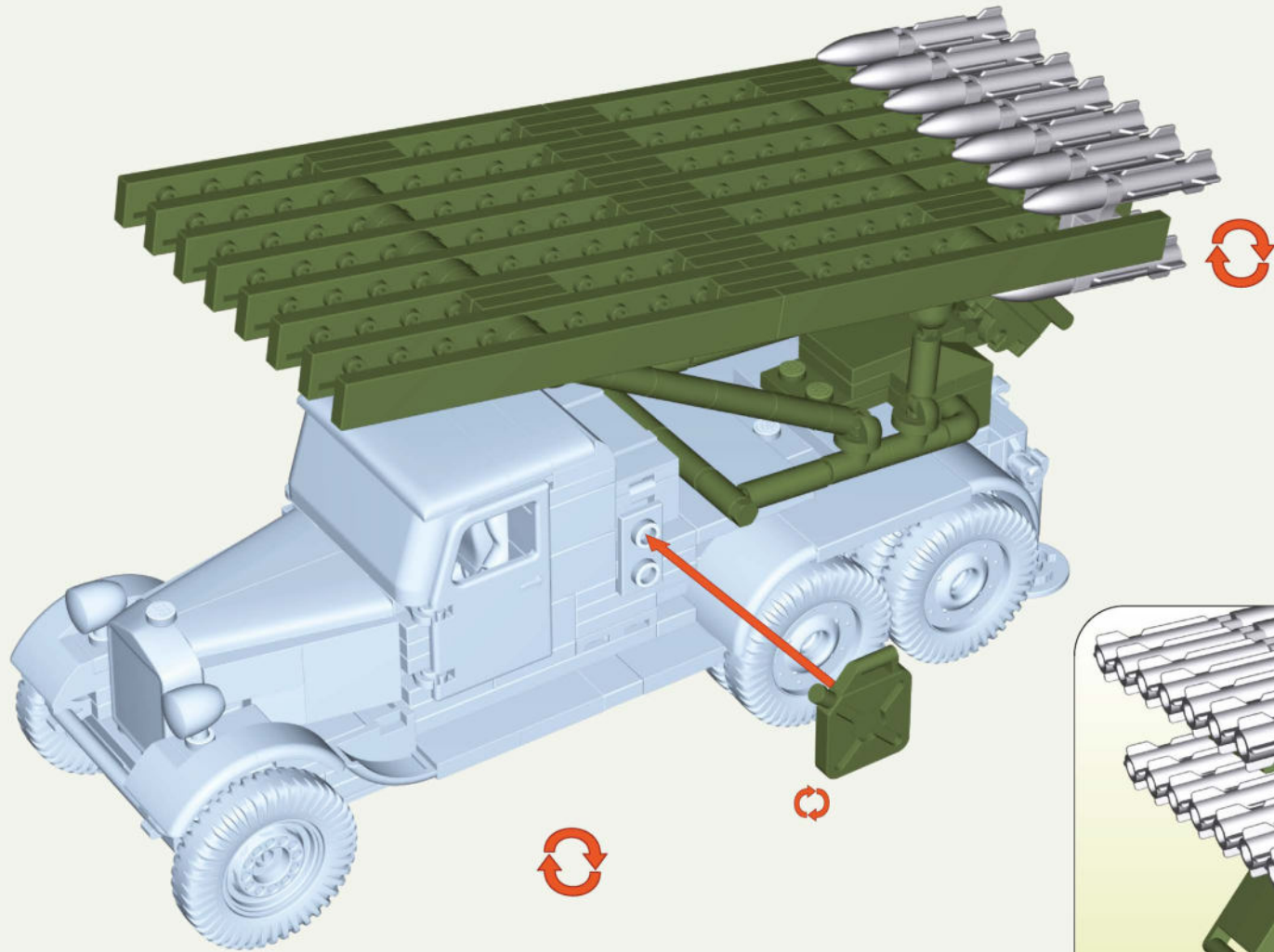

	
<b>x1</b>	<b>x1</b>



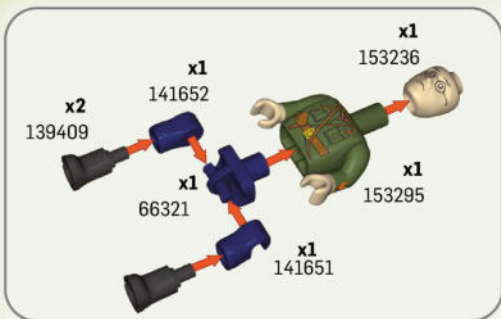

- x6 128622
- x1 109389
- x4 128623
- x1 110093
- x5 44014
- x2 44604
- x1 86093
- x4 42875
- x2 80459
- x14 77142
- x1 150048
- x18 125256
- x2 42882
- x1 150425
- x2 93052
- x4 153306
- x3 42863
- x1 53338

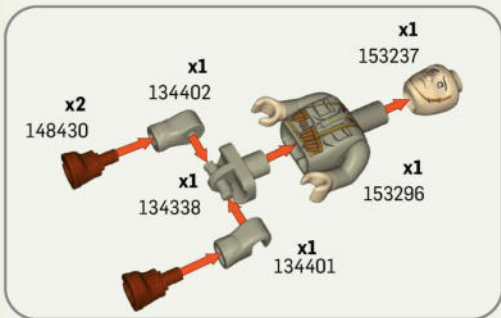

- x22 42931
- x1 42913
- x1 113533
- x3 45540
- x1 105330
- x1 153312
- x2 94039
- x1 150432
- x9 132329
- x1 87333
- x7 42952
- x6 106342
- x1 80005
- x2 42895
- x1 111481
- x1 109698
- x1 42959
- x1 93457

- x3 115502
- x1 44877
- x1 106370
- x2 99234
- x1 147557
- x1 109733
- x7 42976
- x1 153307
- x1 153304
- x4 67985
- x2 105011
- x1 85566
- x2 43017
- x1 128843
- x1 74222
- x12 43048
- x4 70940
- x4 43084
- x4 43100
- x1 43114
- x2 82039
- x5 77515
- x7 124559
- x4 97401
- x1 128897
- x2 43057
- x1 117451
- x2 67979
- x3 43154
- x1 86989
- x4 117835
- x3 43168
- x1 153302
- x1 153309
- x1 124981
- x2 107858
- x1 118356
- x1 113535
- x4 124602
- x2 113555
- x2 43230
- x4 109913
- x2 89462
- x2 90270
- x2 80003
- x1 43240
- x1 153233
- x2 153195
- x2 153194
- x1 153303
- x1 153310
- x2 153311
- x2 153308
- x1 153235
- x3 148917
- x1 104414
- x1 95128
- x2 123440
- x2 152360







# COMPANY OF HEROES 3

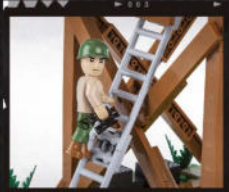

US AIR SUPPORT CENTER

★ 3042



GERMAN FIGHTING POSITION

⊕ 3043



PANZER III Ausf. J  
+ 2562



M4A3 SHERMAN  
+ 2570



Sd. Kfz. 9/1 „FAMO“  
+ 2281



CHURCHILL MK. IV  
SCALE 1:48  
+ 2717

# HISTORICAL COLLECTION

2280

BM-13 KATYUSHA (ZIS 6)



TABLE POINT

1.		23 cm	11.		0
2.		10 cm	12.		0
3.		-5 cm	13.		0
4.		-15 cm	14.		4
5.		+10 cm	15.		-
6.		5-6	16.		2
7.		6	17.		1
8.		14	18.		1
9.		8+	19.		120
10.		0	20.		* Available 1941

\* -1 to hit with Gun, 'small Target



2280



CROMWELL MK.IV  
2269



# HISTORICAL COLLECTION



H.M.C M8 SCOTT  
2279



Sd.Kfz.7 HALF-TRACK  
2275



SHERMAN IC FIREFLY HYBRID  
2276

WWW.COBIGAMES.COM

## BN-13 KATYUSHA (ZIS 6)



WWW.COBI.EU

For news and special deals

Find us on:  
f cobr.bricks  
i cobr.klocki  
y COBI SA

01-02280-426